



DEED 2005073129



JUN 24 2005 10:37 P 114

Nbr Doc	
Stamp Tax	
Date	6/24/05
\$	Ex 4
By	JB

Received - DIANE L. BATTIATO
Register of Deeds, Douglas County, NE
6/24/2005 10:37:38.91



2005073129

DECLARATION AND MASTER DEED OF PARK PLAZA CONDOMINIUM PROPERTY REGIME

B

Deed	648.00	- new
114	16-42360	- old
<u>156.</u>		

Please Return to:
Larry A. Jobeun, Esq.
Fullenkamp, Doyle & Jobeun
11440 West Center Road
Omaha, Nebraska 68144

Re/s 29

**DECLARATION AND MASTER DEED
OF PARK PLAZA CONDOMINIUM
PROPERTY REGIME**

This Declaration and Master Deed of Park Plaza Condominium Property Regime is made and entered into this 20th day of May, 2005, by Park Plaza, a Nebraska general partnership, hereinafter referred to as "Declarant".

WITNESSETH:

WHEREAS, pursuant to the terms of the Nebraska Condominium Act (hereinafter referred to as the "Act"), Declarant, being the sole record owner of the Property legally described in Exhibit "A" attached hereto and incorporated herein by this reference (hereinafter referred to as the "Property") does hereby subject the Property to the condominium form of ownership as "PARK PLAZA CONDOMINIUM ASSOCIATION, INC.," as provided for in the Act and in this Declaration and Master Deed of Park Plaza Condominium Property Regime (hereinafter referred to as the "Declaration").

WHEREAS, by virtue of the recording of this Declaration, the Property shall be owned, held, transferred, sold, conveyed, used, occupied and mortgaged or otherwise encumbered subject to the provisions of this Declaration and the Act and every grantee of any interest in said Property, by acceptance of a deed or other conveyance of such interest, and every Owner of any portion of the Property, whether or not such deed or other conveyance of such interest shall be signed by such person and whether or not such person shall otherwise consent in writing, shall own and take subject to the provisions of the Act and this Declaration and shall be deemed to have consented to the terms hereof.

WHEREAS, in addition to the formation of this Condominium, to be comprised of the Property aforementioned, Declarant hereby further reserves unto itself and its successors and assigns acting as Declarant, Special Declarant Rights, as defined in the Act, to include by way of example and not limitation, the right to exercise Development Rights, as defined in the Act, including the right and option, but not the obligation, in its own discretion and by its own act, to (i) relocate the boundaries of any Unit or Units, and (ii) further subdivide any one or more of the Units into additional Units, Common Elements or Limited Common Elements, and (iii) add real estate to the Condominium such as to include all or any portion of the Additional Property (as defined in Section 1.2, below), all as further provided in Article XV of this Declaration and pursuant to the terms of the

Act. This Declaration shall not apply to or otherwise encumber any or all of the Additional Property until such time as this option and right of Declarant is exercised pursuant to the terms of this Declaration.

WHEREAS, in furtherance of the plan of condominium ownership and the purposes and intents thereof, Declarant, as the sole owner of the Property hereby submitted to the Act and this Declaration, together with all Improvements constructed thereon, hereby makes this Declaration which shall apply to, govern, control and regulate the sale, resale, or other disposition, acquisition, ownership, use and enjoyment of the Property and the Improvements located or to be located thereon, and does hereby specify, agree, designate and direct that this Declaration and all of its provisions shall be and are covenants to run with the Property herein described and shall be binding on the present owner of the Property and all its successors and assigns and all subsequent owners of the Property and Improvements constructed or to be constructed thereon, together with their grantees successors, heirs, executors, administrators, devisees and assigns.

NOW, THEREFORE, Declarant, as the owner of the Property located in Douglas County, Nebraska, and as described in Exhibit "A" attached hereto, for the purposes above set forth, does hereby declare said Property and all Improvements and facilities constructed thereon to be a condominium property regime hereunder known as the Park Plaza Condominium Property Regime, under the Act and in furtherance thereof declares and provides:

ARTICLE I - DEFINITIONS

The following terms, as used herein or elsewhere in any of the Condominium documents relating to the Park Plaza Condominium Property Regime, unless otherwise provided, are defined as follows:

1.1 Act means the Nebraska Condominium Act (Neb. Rev. Stat. §§ 76-825, et. Seq.), as such Act may be amended. The Act is incorporated herein by reference.

1.2 Additional Property means the property legally described as the West End Addition, Lot 16, Block 4 and 7 ½ Feet of the Vacated Alley Adjacent and 50 x 143.5, consisting of approximately .16 acres, which may be added to the Condominium Property Regime in accordance with the provisions of Article XIII of this Declaration and the exercise of Special Declarant Rights inclusive of Development Rights reserved by Declarant to add the real estate to the Condominium

Regime. The Additional Property may be referred to on the Condominium Plans as the Reserved Property.

1.3 Allocated Interests means the undivided interest in the Common Elements and Common Expense Liability allocated to each Unit.

1.4 Articles of Incorporation means the Articles of Incorporation of the Association as the same now exist or may be hereafter amended.

1.5 Association means Park Plaza Condominium Association, Inc.

1.6 Association's Board of Directors, Board of Directors or Board means the Board of Directors of the Association, the members of which shall be elected from time to time as provided in this Declaration, By-Laws and the Articles of Incorporation and shall be elected pursuant to the terms of the Act. The Board of Directors shall be the governing body of the Association and may sometimes herein be referred to as the Board or the Executive Board.

1.7 By-Laws means the duly adopted By-Laws of the Association as may be amended from time to time. (Attached hereto as Exhibit "D")

1.8 City means the City of Omaha, Nebraska.

1.9 Common Elements means all portions of the Condominium other than the Units.

1.10 Common Expenses means expenditures made by or financial liabilities of the Association, together with any allocations to reserves.

1.11 Common Expense Liability means the liability for Common Expenses allocated to each Unit pursuant to the terms of this Declaration and the Act.

1.10 Condominium, Condominium Regime or Condominium Project means the Real Estate described in Exhibit "A" attached hereto and incorporated herein by this reference, portions of which are designated for separate ownership and the remainder of which is designated for common ownership solely by the owners of those portions.

1.12 Declarant means Park Plaza, a Nebraska general partnership and its successors and assigns in interest that succeeds to any Special Declarant Rights inclusive of the Developments Rights.

1.13 Declaration means this Declaration of Condominium for PARK PLAZA CONDOMINIUM PROPERTY REGIME, as such may be amended from time to time.

1.14 Development Rights means any right, or combination of rights, reserved by the Declarant in this Declaration to annex the Additional Property into the Condominium, to create Units, Common Elements or Limited Common Elements within the Condominium and the Additional Property, to subdivide Units or convert Units into additional Units, Common Elements or Limited Common Elements; or to relocate the boundaries of any Unit within the Condominium Regime, including the rights reserved to Declarant as set forth in Article XIII, below, and pursuant to the Act.

1.15 Dispose or Disposition means a voluntary transfer to a Purchaser of any legal or equitable interest in a Unit, but does not include the transfer or release of a security interest.

1.16 Eligible Mortgage Holder means any of the following any first mortgage recorded or filed in the office of the Register of Deeds of Douglas County, Nebraska, encumbering a Unit or any portion thereof as security for the performance of an obligation given in good faith and for valuable consideration which is not a fraudulent conveyance under Nebraska law, but does not mean any instrument creating or evidencing solely a security interest arising under the Uniform Commercial Code or an encumbrance affecting any leasehold interest in a Unit (such as leasehold mortgage).

1.17 Identifying Number means a symbol or address which identifies only one Unit in the Condominium Project.

1.18 Improvements shall mean all buildings, structures, underground installations, slope and grade alterations, lighting, elevators, walkways, gutters, storm drains, drainage ways, utilities, driveways, drainage ways, screening walls, walls, exterior doors, windows, window boxes, awnings, stairs, stairwells, decks, patios, balconies, plantings, planted trees and shrubs, sidewalks, poles, flags, signs, storage or display areas, loading areas, docks, fountains, water features, facilities and all other structures or improvements of every type and kind.

1.19 Limited Common Element means a portion of the Common Elements allocated by this Declaration, the Plans or by the Act for the exclusive use of one or more but fewer than all of the Units.

1.20 Managing Agent means the Person, company, or other legal entity who undertakes the duties, responsibilities and obligations of the management of the Association and the Condominium.

Managing Agent may be employed or terminated by a vote of the Board of Directors, subject to any outstanding contract rights as might exist.

1.21 Parking Space means any parking space located in the parking areas of the Condominium Project as shown on the Plans.

1.22 Period of Declarant Control shall commence with the recording of this Declaration and shall continue until the earlier of (i) sixty (60) days after the date by which seventy-five (75%) percent of the Units have been conveyed to Unit Purchasers, or (ii) two (2) years after the date the Declarant has ceased to offer Units for sale in the ordinary course of its business, or (iii) seven (7) years after the date this Declaration is recorded in the office of the Register of Deeds of Douglas County, Nebraska.

1.23 Person means a natural person, corporation, partnership, limited liability company, business trust, estate, trust, partnership, association, joint venture, government, governmental subdivision or agency, or other legal or commercial entity; provided, however, that for a land trust, "Person" means the beneficiary of the trust rather than the trustee of the trust.

1.24 Plan or Plans means the drawings prepared by a registered architect or engineer which contains the information required by the provisions of the Act and as set forth on Exhibit "B".

1.25 Purchaser means any Person other than a Declarant or a Person in the business of selling Real Estate for his own account, who by a voluntary transfer acquires a legal or equitable interest in a Unit, other than (a) a leasehold interest, including renewal options of less than twenty (20) years, or (b) as security for an obligation.

1.26 Qualified Lender means an Eligible Mortgage Holder, its successors and assigns, or an insurer or governmental guarantor of an Eligible Mortgagee; provided that any such insurer or governmental guarantor has given notice to the Board, in writing, of the existence of such status.

1.27 Special Declarant Rights means rights reserved for the benefit of the Declarant to complete Improvements indicated on the Plans filed with the Declaration; to exercise any Development Rights; to maintain sales offices, management offices, advertising signs for the Condominium Project, and models; to use easements through the Common Elements (including the Limited Common Elements) for the purpose of making Improvements within the Condominium Project; to create or add additional Units, Common Elements, or Limited Common Elements; to

relocate the boundaries between any of the Unit or Units; to subdivide any Unit or Units; to annex the Additional Property and make Improvements thereon; or to appoint or remove any officer of the Association, or any member of the Board of Directors during the Period of Declarant Control.

1.28 Super-Majority Vote shall mean sixty-seven (67%) percent or more of the votes entitled to be cast by the members of the Association at any regular or special meeting of the Association called for that purpose.

1.29 Unit means a physical portion of the Condominium designated for separate ownership or occupancy, the boundaries of which are described in Article II, below, in the Plans and pursuant to the Act.

1.30 Unit Owner or Owner shall mean the fee simple interest Owner of any Unit or Units, including, without limitation, one who is buying a Unit or Units under a recorded contract, but excluding Mortgagees and others who hold such title merely as security. Owner shall not include a Lessee of a Unit or Units.

ARTICLE II - CONDOMINIUM UNITS

2.1 The Units. The Condominium Units shall be legally described as shown on the Plans attached hereto as Exhibits "B". The Condominium Project consists of Fifty Nine (59) Units located on floors 3 through 9 that will be used for residential purposes, and one (1) Unit located on the first floor that will be used for commercial/office purposes. Pursuant to Article XIII, the Declarant reserves the right to add additional Units on the second floor of the Condominium Regime that will be used for residential purposes. Each Unit includes an Allocated Interest that is appurtenant thereto. The Units are further identified on the Plans recorded pursuant to the terms of this Declaration and the Act. Each Unit's appurtenant percentage of undivided interest in the Common Elements shall be allocated as set forth in Exhibit "C" attached hereto and incorporated herein by this reference. The calculation of this allocation, shall be originally calculated by the Declarant based upon a fraction, the numerator of which is the total square footage of the Unit, and the denominator of which is the total square footage of all of the Units within the Condominium Regime; provided, however, the Declarant shall calculate any reallocation of the percentage interests upon the creation of any additional Units, the relocation of the boundaries of any Units, the conversion of Units into Common Elements or Limited Common Elements or the conversion of

Common Elements or Limited Common Elements into Units. For purposes of voting, each Unit is allowed one (1) vote, regardless of the number of Persons having an interest in such Unit. Each Unit may be described by its Identifying Number or symbol as shown on the Plans and as set forth in this Declaration and shall be deemed good and sufficient for all purposes and shall be deemed to convey, transfer, encumber or otherwise affect the Unit Owner's corresponding Allocated Interest even though the same is not expressly mentioned or described therein. Ownership of each Unit and the Unit Owner's corresponding share in the Common Elements shall not be separated. Other than the Declarant, no Unit Owner may relocate the boundaries of any Unit or further subdivide or combine any one or more the Units.

2.2 Dimension of Units. The Units and their dimensions are depicted on the Plans referred to hereinabove which Plans are incorporated herein by this reference. Except as otherwise provided herein, and as otherwise set forth in Article III, which describes the Common Elements, each Unit includes that part of the structure which lies within the following boundaries:

(a) Appurtenances. Each Unit shall consist of all space within the boundaries thereof, as hereinafter defined, and all portions of the building situated within such boundaries, including but not limited to all fixtures, facilities, utilities, equipment, appliances, and structural components designed and intended solely and exclusively for the enjoyment, use and benefit of the Unit wherein the same are located, or to which they are attached, but excluding therefrom that are designed or intended for the use, benefit, support, safety or enjoyment of any other Unit or which may be necessary for the safety, support, maintenance, use, and operation of any of the building or which are normally designed for common use; provided, however, that all fixtures, equipment, appliances, and cabinets designed or intended for the exclusive enjoyment, use and benefit of a Unit shall constitute a part of such Unit, whether or not the same are located within or partly within the boundaries of such Unit. Also, the interior sides and surfaces of all doors and windows in the perimeter walls of a Unit, whether or not located within or partly within the boundaries of a Unit, and all interior walls and all of the floors and ceilings within the boundaries of a Unit, are considered part of the Unit.

(b) Boundaries. The boundaries of each Unit shall be as shown on the Plans without regard to the existing construction measured between the interior unfinished surface of the floors,

roofs and perimeter walls of each Unit. In the event any horizontal or vertical or other boundary line as shown on the Plans does not coincide with the actual location of the respective wall, floor or roof surface of the Unit because of inexactness of construction, settling after construction, or for any other reasons, the boundary lines of each Unit shall be deemed to be and treated for purposes of ownership, occupancy, possession, maintenance, decoration, use and enjoyment, as in accordance with the actual existing construction. In such case, permanent appurtenant easements for exclusive use shall exist in favor of the Owner of each Unit in and to such space lying outside of the actual boundary lines of the Unit, but within the appropriate wall, floor or roof surfaces of the Unit.

ARTICLE III - COMMON ELEMENTS

3.1 Common Elements The Common Elements of the Condominium are as follows:

(a) The Real Estate upon which the structures containing the Condominium Units are located, and such structures themselves, including the foundations, parking structure, exterior walls, roofs, gutters, downspouts, chutes, chases, flues, ducts, wires, conduits, bearing walls, bearing columns, fire suppression and detection systems, whether situated partially within or outside the boundaries of any Unit, including without limitation all piping, fittings, valves and sprinkler heads, or any other fixtures which lie partially within and partially outside of the designated boundaries of a Unit and which serve more than one Unit and are not otherwise assigned or allocated to any one or more Units as a Limited Common Element.

(b) Except as may be shown on the Plans, the Common Elements shall include, without limitation, each and every stairway, elevator, service or utility area and facilities now or hereafter erected, constructed or installed on or in the Property and any adjacent public right-of-ways that the Association is responsible for maintaining, including without limiting the generality of the foregoing, trees, shrubs, lawns, decorative urns and planters, pavements, sidewalks, storm and water systems, sewage lines, and all utility installations, and pipes, wire and conduits and connections for television, electricity, light, water and plumbing and other utilities, except those items that are exclusively within or for the benefit of a particular Condominium Unit and not used to service any Unit other than that particular Condominium Unit.

(c) All other appurtenances not herein specifically designated which are not enclosed within the boundaries of a Condominium Unit as is hereinabove delineated in Article II of this Declaration.

3.2 Undivided Interest in Common Elements. The Owner of each Unit shall own an undivided interest in the Common Elements as a tenant (or tenants) in common with all the other Unit Owners, and, except as otherwise limited in this Declaration, shall have the right to use the Common Elements for the purposes incidental to the use and occupancy of said Unit, and such other incidental uses as may be permitted by this Declaration, which right shall be appurtenant to and run with such Person's or Persons' Unit. The extent and amount of percentage of such ownership shall be expressed by a percentage amount, the particular percentage amount, also sometimes referred to herein as "share", appertaining to each Unit being set forth in Exhibit "C" attached hereto and made a part hereof. The percentage interest appurtenant to the Unit may change in the event any Unit is converted to a Common Element, any Common Element is converted to a Unit or the boundaries of any Unit are relocated as authorized by the Act and this Declaration.

3.3 Allocated Share of Common Elements. The percentage interest or share allocated to each Unit shall be determined as set forth in Article II, above. In the event any portion of the Additional Property is added to the Condominium, then the percentage interest or share so allocated, being the Unit's undivided interest in the Common Elements appertaining to such Unit, shall be allocated and reallocated, respectively, in the same manner as the allocation of undivided interests was done for Units previously existing in the Condominium, to wit, each Unit in the Condominium shall be allocated a percentage interest, being an undivided interest in the Common Elements, determined by the method set forth in Article II hereinabove. Common Elements shall be deemed to include both Common Elements and Limited Common Elements, unless otherwise herein expressed. Each Owner, by acceptance of the deed to a Unit, expressly agrees to the allocation and reallocation of the percentage interest set forth hereinabove or by exercise of any other Special Declarant Right. Allocations and reallocations of the percentage interest may be subject to minor variations attributable to rounding off. The respective percentage interest shall be computed to five significant figures so the sum of the percentage interests of all Units equals one hundred (100%) percent.

3.4 Common Expense Liability. The Common Expense Liability shall be based on the operation and maintenance costs for these Common Elements and the amount of the assessment will change on a yearly basis according to these costs. The Common Expense Liability shall be allocated to each Unit as set forth in Exhibit "C".

ARTICLE IV - COVENANTS

4.1 No Partition of Common Elements. As long as the Property is subject to the provisions of the Act, the Common Elements shall remain undivided, and no Unit Owner or Owners shall bring any action for partition or division of the Common Elements; and any agreement to the contrary shall be null and void. Provided, however, nothing herein contained shall prevent partition of a Condominium Unit as between any Persons who are Co-Owners thereof, if such right of partition shall otherwise be available, but such partition shall not be in kind.

4.2 No Severance of Ownership. No Owner shall execute any deed, mortgage, lease or other instrument affecting title to his or her Unit Ownership without including therein both his or her interest in the Unit and his or her corresponding Allocated Interests, including his or her share in the Common Elements, it being the intention hereof to prevent any severance of such combined ownership. Any such deed, mortgage, lease or other instrument purporting to affect the one without including also the other, shall be deemed and taken to include the interest so omitted even though the latter is not expressly mentioned or described therein.

ARTICLE V - EASEMENTS AND LIMITED COMMON ELEMENTS

5.1 Encroachments. In the event that, by reason of construction, settlement or shifting of any building or structure, any part of the Common Elements encroaches or shall hereafter encroach upon any part of any Unit, or any part of any Condominium Unit encroaches or shall hereafter encroach upon any part of the Common Elements, or if by reason of the design or construction of any Condominium Unit it shall be necessary to a Unit Owner to use or occupy, for normal uses and purposes, any portion of the Common Elements, consisting of an unoccupied space within the Property and adjoining his or her Unit, valid easements for the maintenance of such encroachment and for the use of such adjoining space are hereby established and shall exist for the benefit of such Condominium Unit and the Common Elements, as the case may be, so long as all or any part of the building containing such Unit shall remain standing; provided, however, that in no

event shall a valid easement for an encroachment be created in favor of any Condominium Owner or in favor of the Owners of the Common Elements if such encroachment occurred because of the willful conduct of said Condominium Unit Owner or the Owners of the Common Elements, as the case may be. In the event any structure is partially or totally destroyed and then rebuilt, minor encroachments of part of the Common Elements because of construction shall be permitted and valid easements for said encroachment and the maintenance thereof shall exist.

5.2 Limited Common Elements. Unless the context of this Declaration otherwise requires, Limited Common Elements shall be as provided in the Act and assigned and allocated exclusively to the Units so served. The Board shall be expressly empowered and authorized to allocate parking exclusively to a Unit as shown on the Plans, which if allocated, shall be deemed to be a Limited Common Element appurtenant to such individual Unit. Allocation of such Parking Spaces shall be done pursuant to a License Agreement, which shall be in a form acceptable to Declarant during the Period of Declarant Control and thereafter by the Association. In furtherance of the foregoing, a valid exclusive easement is hereby declared and established for the benefit of each Licensee consisting of the non-exclusive right to use and enjoy the Limited Common Elements hereby established, including, but not limited to, those portions of the Parking Facility, as shown on the Plans designated for the Unit Owners. Any Unit Owner may, with the prior written consent of the Association, which consent shall not be unreasonably withheld, reallocate, convey and transfer Parking Spaces among or between any Units by assignment, lease, easement or license; provided, however, any such assignment shall be subject to all rules and regulations adopted by the Association from time to time. Notwithstanding the foregoing, any Parking Space within the designated parking areas may be licensed, used or occupied by Licensee or their Authorized Users (as defined in the License Agreement). Neither the Board nor any committee shall have the right or authority to reassign or reallocate any Parking Space held by a Licensee without the prior written consent of the Licensee affected thereby.

5.3 Easement to Unit Owners. Except as to the use of any Unit or Limited Common Elements that are assigned and allocated to any Unit or that are assigned and allocated exclusively to any other Unit, perpetual easements are hereby established for all Unit Owners, their families, guests, invitees, mortgagees and servants for the use and enjoyment of all Common

Elements, subject to such rules and regulations as may from time to time be established by the Association herein provided. Except for the rights of the Declarant herein, no Owner of a Unit shall have any right to access, occupy or use any Limited Common Elements exclusively assigned and allocated to any other Unit.

5.4. Landscape Maintenance Easements. The Association shall have a non-exclusive easement over, under, across and through the Common Elements for purposes of installing, maintaining and repairing landscaping and landscape facilities therein. The costs thereof shall be included in the Association's budget for assessment against the Condominiums in the manner provided in Article VIII, below.

5.5 Utility Easements.

(a) The Association shall maintain all utility lines and facilities located in, on, or under the Common Elements, except for those lines and facilities maintained by utility companies (public, private or municipal) and those required to be maintained by the Owners pursuant to subsection (b), below, or the Master Association. The Association shall pay all charges for utilities supplied to the Condominium Property, except those metered or charged separately to the Condominium Units.

Accordingly, if any utility line or facility which the Association is required to maintain, repair or replace becomes clogged, stopped-up, damaged, destroyed or otherwise requires repair, the Association shall furnish such maintenance, replacement or repair, including repair of any collateral damage or loss in the Common Elements or any Improvements therein. However, if it can be determined that the cause of such clogging, stoppage, damage, destruction or repair originated in any particular Unit (or was caused by an act of an Owner or any of his/her agents, guests, or members of his/her family, whether or not such act was negligent or culpable), the Association may charge the Owner of the Unit the cost of the repair, replacement or maintenance. If one or more Owners fail to pay such costs, the Association may collect them by levying a special assessment upon the Unit or Units of the Owners who are responsible therefore under the provisions of this subsection. Except as otherwise provided herein, the Association shall not be responsible for damage to any Unit or personal property located therein caused by a damaged or defective utility line or facility.

In the event of a failure or inability of the Board to take timely action to maintain, replace or repair utility lines or facilities for which it is responsible (including repair of any collateral damage or loss in the Common Element), the Owners of any Unit or Units served by the lines or facilities shall have the right, and are hereby granted an easement to the full extent necessary therefore, to enter upon Units, Common Elements or Limited Common Elements which these lines, facilities or any portion thereof are located to repair, replace or maintain them (including collateral damage as provided above). The Association shall reimburse the Owner(s) for the reasonable and necessary costs incurred by the Owner(s) in making such maintenance, repair or replacement. If entry onto the Common Elements, Limited Common Elements or Units is required hereunder, the party making such entry must give reasonable notice to the Association and/or Owner of such Unit as applicable.

(b) Unless maintained by a utility company, an Owner shall be deemed to own the utility lines and facilities and outlets of all utility lines and facilities located within and serving only his/her Unit, and shall be responsible for the maintenance of such utility lines, facilities and outlets.

(c) Whenever such utility lines or facilities serve more than one Unit, the Owner of each Unit served by the lines or facilities shall be entitled to the full use and enjoyment of the portions of the lines or facilities as service his/her Unit.

5.6 Easements in Gross. The Property shall be subject to a perpetual easement in gross to the Association provided herein, its successors and assigns, for ingress and egress, to perform its obligations and duties as required by this Declaration. Should it be necessary to enter any Condominium Unit to repair a Common Element or Limited Common Element, the employees, agents, contractors, subcontractors, or workmen shall be entitled to entrance during reasonable hours with 24 hours prior written notice, unless it is reasonably believed by the Board that an emergency exists which requires such entrance without advanced notice, by exhibiting to the Condominium Owner or any Person or Persons occupying such Unit under authority of such Condominium Unit Owner, an order signed by any member of the Board of Directors or signed by the Managing Agent.

5.7 Granting of Easements. The Association, acting through the Board, shall have the power to grant rights and restrictions, in the Common Elements, such as the rights to grant utility

easements, licenses, or similar rights, including easements for cable television, under, through or over Common Elements as may be reasonably necessary to or desirable for the ongoing development or operation of the Condominium.

5.8 Easements in Units. To the extent that any utility line, pipe, wire or conduit serving any Unit shall be wholly or partially within the boundaries of another Unit, such other Units shall be burdened with and there hereby is reserved and created an easement for the use, maintenance, repair and replacement of such utility line, pipe, wire or conduit, such easement to run to the benefit of the Unit or Units served by the same.

5.9 Sales Office. The Declarant, its duly authorized agents, representative and employees shall have an easement for the maintenance of a sales offices and/or model Units on the Property so long as Declarant owns or occupies any Condominium Unit primarily for the purpose of sale. Such sales offices and/or model Units may be maintained in such number and size as determined by the Declarant and may be located and relocated in Units and/or in any improvements on the Common Elements. By execution hereof, the Declarant does hereby specifically reserve an easement for the use of the Common Elements as may be located within the Property as a sales and marketing office of the Declarant during the development of the Property, and for one (1) year after the last Condominium Unit located on the Property is sold, which easement shall be for exclusive use of the Common Elements unto the Declarant, to the exclusion of use of such Common Elements by any Owner. Exercise of the rights of such easement shall be by Declarant and its designates.

5.10 Easement for Improvements. Declarant shall have and does hereby reserve a transferable easement on and over the Common Elements for the purpose of making improvements contemplated by this Declaration on the Property, and for the purpose of doing all things reasonably necessary and proper in connection therewith.

5.11 Effect of Easements. All easements and rights herein established shall run with the land and inure to the benefit of and be binding on the Declarant, its successors and assigns, and any Condominium Unit Owner, Purchaser, mortgagee, or other Person having an interest in any portion of the Property herein described, whether or not such easements are maintained or described in any deed of conveyance.

5.12 Restoration of the Condominium. The benefited party of any easement granted hereunder shall have the duty and obligation to repair and restore the servient portion of the Condominium to the condition which existed prior to the exercise of such easement rights.

ARTICLE VI – RESTRICTIONS

6.1 Permitted Uses - Units.

(a) Other than the Special Declarant Rights carried on by the Declarant or its assigns, agents or successors, during the Period of Declarant Control, the Units located on the third (3rd) through the ninth (9th) floor and any additional Units created on the second (2nd) floor shall be restricted to single family residential use and may not be used for any other purpose. Nothing in this Section 6.1 is intended to prohibit an Owner from keeping his personal business or professional records or accounts therein, or handling his personal business calls or correspondence therefrom.

(b) Except as otherwise provided herein, and subject to all other provisions of this Declaration and to all other restrictions and limitations in any subsidiary declaration or other recorded restrictions executed by Declarant, any Unit or Units located on the first floor of the Condominium Regime may be used or occupied pursuant to any permitted, conditional or special uses allowed within the R8 base district of the Omaha Municipal Code; provided, however, each such use shall be first expressly approved by the Declarant during the Period of Declarant Control, and thereafter by the Association, which consent shall not be unreasonably withheld or delayed.

6.2 Prohibited Uses - All Units, Common Elements and Limited Common Elements. In addition to all restrictions now existing against said Property and all Improvements now or hereafter constructed thereon, the use, occupancy and operation of the Units, Common Elements and including Limited Common Elements is hereby expressly restricted as follows:

(a) Animals. No animals, livestock, or poultry of any kind shall be raised, bred, or kept on any part of the Property, except that dogs, cats or other usual household pets may be kept by the respective owners in their respective Units, provided that they are not kept, bred, or maintained for any commercial purpose and do not endanger the health or unreasonably disturb the Owner of any Units or any resident thereof. The Board of Directors shall make reasonable rules and regulations for the accommodation of pets.

(b) Use of Property. Except for the right of ingress and egress, the Owners of Units are hereby prohibited and restricted from using any property outside of their respective Units, except as may be allowed by the Association's Board of Directors or as expressly provided herein. It is expressly acknowledged and agreed by all parties concerned that this paragraph is for the mutual benefit of all Owners within the Condominium Regime and is necessary for the protection of the Owners.

(c) Antennas. No television antenna or radio receiver, satellite dish, or other similar device shall be attached to or installed on any portion of the Property, unless contained entirely within the interior of a Unit or the roof of the building; provided, however, any such installation on the roof of the building shall be approved in writing by the Board and performed by the Association's contractor at the Unit Owner's expense. No radio or television signals, nor any other form of electromagnetic radiation, shall be permitted to originate from any Unit, which may unreasonably interfere with the reception of television or radio signals within the Condominium; provided, however, that Declarant and the Association shall not be prohibited from installing equipment necessary for the operation of any master antenna, security, cable television, mobile radio, or other similar systems within the Condominium.

(d) Vehicles, Etc. No vehicles shall be parked on the Common Elements, other than in authorized Parking Spaces, and no vehicle repairs, other than emergency repairs or repairs of a minimal nature needed to be performed to move a vehicle off the Property, shall be allowed on the Property. No vehicles shall be parked or stored on blocks or other such devices on the Common Elements or any other portion of the Condominium. Outside parking associated with the building is currently leased and limited to the use of the commercial users of the building from Monday through Friday from 8 a.m. to 6 p.m. Visitors and Unit owners are prohibited from parking in that area, and are subject to the Association's right to tow away during those times. No vehicles shall be parked so as to obstruct the fire lanes or roadways as may exist within the Condominium. The Association is expressly authorized to tow away, at an offending Owner's expense, any vehicle which is in violation of this Section, or which is placed on the Condominium Property in violation of the rules and regulations governing parking as may be adopted by the Board of Directors. No boats, boat trailers, campers, canoes, recreational vehicles, vehicles used primarily for recreational purposes, vehicles

primarily used for commercial purposes, or vehicles with commercial writings on their exterior shall be stored, allowed to remain, or parked on any portion of the Condominium, except in an area, if any, designated by the Board of Directors or except as otherwise permitted by the Association's Board of Directors or Declarant. The Board shall have the right to designate areas within the parking garage, of the Condominium for the parking of motorcycles and bicycles.

(e) Signs. Except as placed or erected by Declarant or his assigns, agents or successors, no signs, billboards or objects shall be erected, placed, or permitted to remain on the Property, nor shall such Property be used in any way or for any purpose which may endanger the health or unreasonably disturb the Owner of any Unit. No Unit Owner shall display a "for rent" or "for sale" sign without the express written consent of the Board.

(f) Miscellaneous Prohibited Uses. No Unit shall be occupied, operated or maintained in an unsanitary or hazardous condition.

6.3 Security and Frozen Pipes. Should a Unit become vacant, the Owner is responsible for securing the Unit while it is unoccupied, including engaging all locks, providing security lighting, and heating the interior sufficient to keep pipes from freezing. Insurance claims or costs incurred by the Association or the Board for frozen pipe damage in unheated Unit may be offset by a special assessment levied against the Unit in an amount equal to the damage claim.

6.4 Unightly Appearances. No offensive or unsightly appearance shall be maintained or allowed to exist on those portions of any Unit visible from the exterior of the Condominium or Common Areas, i.e., the halls, etc. All equipment, garbage cans, and storage areas shall be kept in a manner so as to conceal them from view of neighboring Units and streets, unless otherwise authorized by the Association's Board of Directors; provided, however, exterior personal patio furnishings, such as chairs, grills and swings, located within a Unit's balcony, patio, porch, terrace, or deck shall be permissible, subject to the rules and regulations of the Association. Provided further, however, that nothing shall be permitted which in the opinion of the Association's Board of Directors jeopardizes the structural integrity of any deck or other part of the Condominium, or which presents risk of damage to adjacent Property shall be permitted.

6.5 Acts Affecting Insurance. An Owner shall not permit or suffer anything to be done or kept in his or her Unit which will increase the rate of insurance acquired by the Association or which will otherwise obstruct or interfere with the rights of other Owners.

6.6 Trash Containers and Collection. No garbage or trash shall be placed or kept on the Condominium except in covered containers of a type, size and style which are approved by the Board. The Board shall have the right to subscribe to a trash service for the use and benefit of the Association and all Owners; and to adopt and promulgate rules and regulations regarding garbage, trash, trash containers and collection. The Board shall have the right to require all Owners to place trash and garbage in containers located in areas designated by the Association's Board of Directors. No incinerators shall be kept or maintained in any Unit. All rubbish, trash, and garbage shall be regularly removed from the Property and shall not be allowed to accumulate thereon. If trash dumpsters are used to facilitate trash, rubbish and garbage removal, all such trash, rubbish and garbage shall be placed therein for removal from the Property

6.7 Machinery and Equipment. Except on the first (1st) floor of the Condominium Regime, no machinery or equipment of any kind shall be placed, operated or maintained upon the Condominium, except such machinery or equipment as is usual and customary in connection with the Declarant's sales, marketing, maintenance or construction of the Improvements which are within the permitted uses of such Property, or any machinery or equipment of any kind as is usual and customary in connection with the operation and maintenance of the Common Elements and Units by the Declarant or the Association.

6.8 Leasing of Units. A Unit Owner may lease his or her Unit and/or Parking Space(s) (but not less than his or her entire Unit) at any time and from time to time provided that:

- (a) No Unit may be leased for transient or hotel purposes or for an initial term of less than 180 days, unless such tenancy exists prior to the recordation of this Declaration.
- (b) No Unit may be leased or subleased without a written lease or sublease.
- (c) A fully executed copy of such lease or sublease shall be furnished to the Board for approval not less than ten (10) days prior to the date the lessee or sublessee obtains possession of the Unit. In the event the Board does not approve the lease in writing within five (5) days after the lease has been furnished to the Board, the lease shall be deemed to have been approved by the Board.

(d) Seventy (70%) percent or more of the Units used for residential purposes shall be owner occupied.

(e) The rights of any lessee of a Unit shall be subject to, and each such lessee shall be bound by, the covenants, conditions and restriction set forth in the Declaration, By-Laws and Rules and Regulations, and a default thereunder shall constitute a default under the lease or sublease; provided, however, that the foregoing shall not impose any direct liability on any lessee or sublessee of a Unit to pay any Common Expenses or special assessments on behalf of the Owner of that Unit.

6.9 Lawful Use. No improper or unlawful use shall be permitted on any part of the Condominium. All valid laws, zoning ordinances, and regulations of all government bodies having jurisdiction over the Condominium shall be observed. Any violation of such laws, zoning ordinances or regulations shall be a violation of this Declaration.

6.10 Nuisances and Offensive Activity. No Owner, lessee, occupant, or other Person shall create a nuisance within the Condominium Regime, or use any portion of the Condominium Regime for any activity or purpose which is considered by the Board, its sole and absolute discretion, to be objectionable due to sound, odor, visual effect or physical impact and which in the opinion of the Board will disturb or tend to disturb other Owners or lessees in the Condominium, or which is deemed by the Board to constitute a nuisance. Included among the uses or activities prohibited because of their detrimental effect upon the general appearance, enjoyment and use of the Condominium are, without limitation, the following:

- (a) Any public or private nuisance.
- (b) Any vibration, noise, sound or disturbance that is objectionable due to intermittence, beat, frequency, shrillness, loudness or pulsating effect.
- (c) Any lighting which is flashing or intermittent or is not focused downward or away from any Unit within the Condominium, unless otherwise approved by the Board.
- (d) Any air pollution, including without limitation any dust, dirt, mold, microbials or other environmental pollutants in excessive quantities.
- (e) Any emission of excessive and offensive or noxious odors.

No nuisance shall be permitted to exist or operate upon the Condominium and no activity shall be conducted upon the Condominium which is offensive or detrimental to any portion of the Condominium or any Owner or Occupants of the Condominium. No exterior speakers, horns, whistles, bells or other sound devices except security or other emergency devices used exclusively for security or emergency purposes shall be located, used or placed on or in the Condominium.

6.11 Enforcement. This Declaration, including all restrictions set forth herein, and the rules and regulations may be enforced by injunctive relief, specific performance or the imposition of reasonable monetary fines as provided in the Act and suspension of use and voting privileges. These powers, however, shall not be construed as limiting any other legal means of enforcing the use restrictions or rules and regulations of the Association. Any fines so imposed shall be considered an assessment against the Unit and may be collected in the manner provided for collection of other assessments. In addition to the foregoing, if any Person shall fail to maintain its Unit in a reasonably safe and sanitary condition, the Association may, at the Board's option, and after ten (10) days written notice to the Unit Owner, perform any clean-up, repair and/or replacement to cure any such condition, and all cost and expenses reasonably incurred by the Association, plus interest thereon at the rate of sixteen (16%) per annum, shall be reimbursed to the Association by such Unit Owner within thirty (30) days after work has been completed. The Association may levy a special assessment against any such Unit, which may be enforced in accordance with Section 10.9, below.

ARTICLE VII - MAINTENANCE

7.1 Maintenance of Condominium Units and Limited Common Elements.

(a) By the Owner. Except as provided in subsection (b) of this Section, each Owner shall have the obligation to maintain, keep attractive, keep in good repair, and replace (subject to applicable and available insurance proceeds) all portions of the Unit and any Limited Common Elements exclusively allocated to such Unit. Any maintenance, repair, replacement or upkeep required to be performed by an Owner hereunder shall be in conformance with the standards as set forth by the Board.

In explanation of the foregoing and not to be construed as a limitation, each Owner shall maintain, repair, and keep in good condition (subject to the Association's obligations hereinafter set forth), his or her Unit.

(b) By the Association. The Association shall maintain, keep in good repair and upkeep, and replace (subject to available insurance proceeds), as a Common Expense assessed in accordance with this Declaration, all of the Condominium property not required to be maintained and kept in good order by a Unit Owner and as otherwise set forth in this Section. The Association shall, by way of explanation and not limitation, be responsible to maintain, keep attractive, keep in good repair and replace all of the Common Elements. The Association shall, also, be responsible for the repair, upkeep and maintenance of all roofs and foundations in respect to Improvements containing the Units or otherwise and the parking garage. In the event the need for maintenance, repair or replacement which is the responsibility of the Association hereunder is caused through the willful or negligent act of an Owner, his or her family, guests, lessees, or invitees, then, the Association shall give the Owner written notice of the repair, replacement or maintenance work needed and an estimated cost to accomplish such repair, replacement or maintenance work. The Owner shall have fifteen (15) days within which to pay the Association such estimated costs, and in the event of a failure to pay, such costs shall be added to and become a part of the assessment to which such Owner is subject and shall become a lien against the Unit.

Despite any provision herein contained to the contrary, the Association shall not be liable for injury or damage to any Person or property: (i) caused by the elements or by any Unit Owner or by any other Person; (ii) resulting from any rain, water, snow or ice which may leak or flow from any portion of the Common Elements; or, (iii) caused by the leaking, failure or disrepair of any pipe, plumbing, drain, conduit, appliance, equipment or utility lines or facilities, the responsibility for the maintenance of which belongs to the Association.

In addition, the Association shall be responsible for the maintenance of sewer lines within the Units as extended from each Unit to the main sewer line connecting on to the Condominium Property.

(c) Failure to Maintain. If the Board of Directors of the Association determines that any Owner has failed or refused to discharge his or her obligations with regard to the maintenance, repair, upkeep or replacement of any items for which he or she is responsible hereunder, including, but not limited to, a failure to maintain, repair or replace a condition which may increase the possibility of fire or other loss or damage to the Condominium, then the

Association (except no notice shall be required in an emergency situation in which case the Association may proceed immediately) shall provide the Unit Owner with written notice specifying the nature of the maintenance, repair or replacement and the estimated costs thereof with reasonable particularity. The Owner shall have fifteen (15) calendar days to complete any such repairs, maintenance or replacements; provided, however, the Unit Owner shall have more than fifteen (15) days if such performance cannot reasonably be completed within fifteen (15) days and the Unit Owner is diligently pursuing the completion. In the event the Owner fails, neglects or refuses to repair, maintain or replace any such items within fifteen (15) days after the receipt of the notice, then the Association, through its Board, shall have the right to cause the repairs, maintenance or replacements to be made, and the Unit Owner shall, within thirty (30) days after the completion of such work, reimburse the Association. In the event any such repair or replacements are to the Common Elements the Association shall complete all such work, and the Unit Owner responsible for such repairs, maintenance or replacements shall have thirty (30) days after demand is made to reimburse the Association. Any costs incurred by the Association under this Section shall be added to and become a part of the assessment to which such Owner is subject and shall become a lien against the Unit.

ARTICLE VIII - ASSOCIATION AND BY-LAWS, ASSESSMENTS

8.1 General Information. The Association will administer the Condominium pursuant to the terms and conditions set forth in this Declaration and the By-Laws. The fiscal year of the Association shall be the calendar year. The Office of the Association shall be located at such location as the Board of Directors or the Managing Agent shall designate from time to time. All Unit Owners, by virtue of their ownership of a Unit in the Condominium, are automatically mandatory Members of the Association and shall be entitled to vote on all matters upon which Members of the Association are entitled to vote, pursuant to this Declaration and in accordance with the By-Laws. The foregoing is not intended to include persons or entities who hold an interest merely as security for the performance of an obligation. Subject to the provisions of the Condominium Documents, the Owner or Owners of each Unit shall be entitled to one (1) vote for such Unit in which the interest required for membership is held. Each Unit is allocated a vote equal in weight to each other Unit. Provided however, if a Unit Owner shall have, in the sole opinion of the Board, an unresolved

financial delinquency with respect to the Association, such Owner's vote shall not be eligible and shall not be entitled to be cast or counted.

8.2 Meetings and Voting. Annual and Special Meetings of the Association, including all notice and quorum requirements and voting of the membership shall be set forth in the By-laws. .

8.3 Directors. During the Period of Declarant Control, the business of the Association shall be managed by a Board of Directors comprised of at least three (3) Directors who shall be appointed by the Declarant and shall serve without compensation. Without regard to the time when the Period of Declarant Control terminates, the Association shall hold a First Transitional Election not later than sixty (60) days after the conveyance of twenty-five (25%) percent of the Units to Unit Owners other than Declarant, at which election one (1) additional member shall be elected to the Board. A Second Transitional Election shall be held by the Association not later than sixty (60) days after the conveyance of fifty (50%) percent of the Units to Unit Owners other than Declarant, at which election one (1) additional member shall be elected to the Board. The qualification, election, term, removal, resignation and replacement of each Board member shall be determined in accordance with the By-laws. The Declarant may voluntarily surrender the right to appoint and remove officers and members of the Board before termination of the foregoing. In that event, the Declarant may require, during the Period of Declarant Control, that the actions of the Association or Board of Directors, as might be described in a recorded instrument executed by Declarant, be approved by the Declarant before they become effective. At end of the Period of Declarant Control, the membership of the Board shall always be comprised of five (5) Persons.

8.4 Director's Meetings. Regular and Special Meetings of the Board of Directors, including the notice and quorum requirements and voting of the Board, shall be set forth in the By-laws.

8.5 Powers and Duties of the Board of Directors. All of the powers and duties of the Association existing under the Act, the Declaration of Condominium and By-Laws shall be exercised by the Board of Directors, its duly appointed agents, contractors or employees, subject only to approval by the Unit Owners where specifically required. Compensation of employees of the

Association shall be fixed by the Directors. A Director may be an employee of the Association and a contract for management of the Condominium may be entered into with a Director or the Declarant.

8.6 Officers. The executive officers of the Association shall consist of a President, who must also be a Director, a Vice-President, Treasurer, and Secretary. The By-laws shall provide for: (i) the election of officers; (ii) the resignation; (iii) removal; (iv) vacancy; and (v) powers, duties and responsibilities of the officers of the Association.

8.7 Assessments.

(a) All Owners shall be obligated to pay the estimated assessments imposed by the Board of Directors of the Association to meet the Common Expenses. The Common Expenses of the Association shall be assessed among all of the Condominium Unit Owners in accordance with the Owner's share in the Common Elements or Limited Common Elements as set forth in Article II of this Declaration. Assessments for the estimated Common Expenses of the Association shall be due in advance of the first day of each calendar month or less frequently as may be determined by the Board of Directors.

(b) Each Unit Owner's obligation of payment of assessments shall begin on the first day of the month in which the closing of the purchase of the Condominium Unit occurs. Each Unit Owner shall pay two (2) months of assessments in advance on the date the closing of the Condominium Unit occurs to fund the reserve account of the Association.

(c) In the event the ownership of a Condominium Unit, title to which is derived from Declarant, commences on a day other than the first day of the assessment period, the assessment for that period shall be prorated.

(d) Assessments shall be based upon the cash requirements deemed to be such aggregate sum as the Board of Directors of the Association shall from time to time determine and is to be paid by all of the Condominium Unit Owners to provide for the payment of all estimated expenses growing out of or connected with the maintenance, repair, operation, additions, alterations and improvements of and to the Common Elements and those Limited Common Elements which are the responsibility of the Association, and the Property and Improvements owned thereby, which sum may include, but shall not be limited to: management fees, expenses and liabilities incurred by the Managing Agent, taxes and special assessments (until separately assessed), snow removal, road and

sidewalk repair, premiums for insurance, landscaping and care of grounds, common lighting and heating, repairs and renovation, trash and garbage collections, wages, common water and sewer charges, legal and accounting fees, management fees, expenses and liabilities incurred by the Managing Agent, if any, on behalf of the Unit Owners under or by reason of the Declaration and By-Laws of the Association for the creation of a reasonable contingency, reserve, working capital and sinking funds as well as other costs and expenses relating to the Common Elements or Limited Common Elements which are the responsibility of the Association.

(e) Pursuant to the provisions of the Declaration and By-Laws, the Board of Directors may levy such assessments for the purpose of defraying the cost of repair or reconstruction of the Improvements in the event of their damage.

(f) The Association by its Board of Directors may levy a special assessment against any individual Unit or any Unit Owner for the reasonable expense incurred in the reconstruction or repair to the Common Elements, Limited Common Elements or the individual Unit for damage or destruction caused by the misconduct, negligence or infraction of the published rules and regulations of the Association by the Unit Owner, his guests or invitees.

(g) The omission or failure to fix the assessment or deliver or mail a statement for any period of time shall not be deemed a waiver, modification or release of the Owner's obligation to pay the same.

(h) The Board shall, pursuant to Section 76-873(c) of the Act, have the power and authority to assess any Common Expenses benefiting fewer than all of the Units exclusively against the Units benefited thereby as contemplated in the Act.

(i) The Association shall have all of the powers of the Association enumerated in the Act.

(j) Within thirty (30) days after adoption of any proposed budget for the Condominium, the Board of Directors shall provide a summary of the budget to all the Unit Owners, and shall set a date for a meeting of the Unit Owners to consider ratification of the budget, which date shall not be less than fourteen (14) no more than thirty (30) days after mailing of the summary. Unless at that meeting a majority of all the Unit Owners, reject the budget, the budget is ratified, whether or not a quorum is present. In the event the proposed budget is rejected, the periodic budget

last ratified by the Unit Owners shall be continued until such time as the Unit Owners ratify a subsequent budget proposed by the Board of Directors.

8.8 Owner's Personal Obligation for Payment of Expenses. The amount of the Common Expenses assessed by the Association against each Condominium Unit shall be the personal and individual debt of the Owner thereof. No Owner may exempt themselves from liability for this contribution towards the Common Expenses by waiver of the use or enjoyment of any of the Common Elements, the Property and Improvements owned by the Association or by abandonment of their Unit. The Board of Directors shall have the responsibility to take prompt action to collect any unpaid assessments which remain unpaid for more than ten (10) days from the date for payment thereof. The failure to make payment of any assessments or installment thereof related to any Unit before the tenth (10th) day after the due date shall constitute a default and such Unit Owner shall: (a) pay a late charge of five (5%) percent on the outstanding balance; and (b) all amounts that are delinquent shall bear interest from the due date at a rate equal to sixteen (16%) percent per annum or the maximum interest rate allowed by law, whichever is less, and all costs and expenses incurred by the Board or its authorized representative in the collection of the amounts, including reasonable attorneys' fees and costs, shall be part of the assessment past due and the full assessment shall be a lien against such Unit. Suit to recover a money judgment for unpaid Common Expenses shall be maintainable without foreclosing the lien nor shall such suit be construed to be a waiver of the lien.

8.9 Association Lien for Non-Payment of Common Expenses.

(a) All sums assessed by the Association but unpaid for the share of Common Expenses chargeable to any Condominium Unit shall constitute a lien on such Unit superior to all other liens and encumbrances, except for (i) taxes and special assessment liens of the Condominium Unit in favor of any assessing entity, and (ii) all sums unpaid to any Eligible Mortgagee of record, including all unpaid obligatory sums as may be provided by such encumbrances. To evidence such lien, the Board of Directors shall prepare a written notice of lien assessment setting forth the amount of such unpaid indebtedness, the amount of the accrued interest and late charges thereon, the name of the Owner of the Condominium Unit and a description of the Condominium Unit. Such notice of lien shall be signed by one of the members of the Association's Board of Directors or by one of the officers of the Association on behalf of the Association and shall

be recorded in the Office of the Register of Deeds of Douglas County, Nebraska. Such lien shall attach and be effective from the due date of the assessment until all sums, with interest and other charges thereon, shall have been fully paid.

(b) Such lien may be enforced by the foreclosure of the defaulting Owner's Condominium Unit by the Association in the manner of a deed of trust or mortgage on real property upon the recording of a notice of claim thereof. In any such proceedings, the Owner shall be required to pay the costs, expenses and attorney's fees incurred for filing the lien, and in the event of foreclosure, all additional costs, all expenses and reasonable attorney's fees incurred. The Owner of the Condominium Unit being foreclosed shall be required to pay the Association the monthly assessment for the Condominium Unit during the period of foreclosure, and the Association shall be entitled to a receiver during foreclosure. The Association shall have the power to bid on the Condominium Unit at foreclosure or other legal sale and to acquire and hold, lease, mortgage, vote the votes appurtenant to, convey and otherwise deal with the same.

(c) Any Qualified Lender holding a lien on a Condominium Unit may pay, but shall not be required to pay, any unpaid Common Expenses payable with respect to such Unit, and upon such payment, such Qualified Lender shall have a lien on such Unit for the amount paid of the same rank as the lien of its mortgage or encumbrance without the necessity of having to record a notice of claim of such lien. The Association shall report to the Qualified Lender of a Condominium Unit any assessments remaining unpaid for longer than sixty (60) days after the same are due; provided, however, that a Qualified Lender shall have furnished to the Association notice of its encumbrance.

(d) The recorded lien may be released by a Release of Lien signed by one of the members of the Association's Board of Directors or by one of the officers of the Association on behalf of the Association and recorded in the Office of the Register of Deeds of Douglas County, Nebraska.

(e) Notwithstanding any of the foregoing provisions, any Qualified Lender who obtains title to a Condominium Unit pursuant to the remedies set forth in its mortgage or deed of trust shall take title to the Unit free and clear of all Common Expense assessments levied thereon prior to such transfer of title and free and clear of all liens created as a result of such assessments.

8.10 Ascertainment of Unpaid Common Expenses.

(a) The Unit Owners and their mortgagees, prospective mortgagees or prospective grantees, upon ten (10) days written notice to the Board of Directors and upon payment of a reasonable fee, shall be furnished a statement of their account. The statement of account shall include the amount of any unpaid Common Expenses, the amount of the current assessments, the dates that assessments are due, the amount for any advanced payments made, prepaid items such as insurance policy premiums and reserves therefor and any deficiencies in reserve accounts such statement shall be conclusive upon the Association in favor of all persons who rely therein in good faith. Unless such request shall be complied with within twenty (20) days after receipt of such written request, all unpaid Common Expenses which become due prior to the date of such request will be subordinate to the rights of an Eligible Mortgagee requesting such statement.

(b) The provisions set forth in this Section shall not apply to the initial sales and conveyances of the Condominium Units made by Declarant, and such sales shall be free from all unpaid Common Expenses to date of conveyance made or to a date as agreed upon by Declarant and Declarant's grantee.

8.11 Priorities of Association and Recreational and Maintenance Association Lien for Common Expenses. The Owner of a Condominium Unit may create junior deeds of trust or mortgages (junior) to the lien, deed of trust or other encumbrances of an Eligible Mortgage or other liens or encumbrances of the Condominium Unit; provided, however, that any such junior mortgage, deed of trust, lien or encumbrance will always be subordinate to the prior and paramount lien of the Association for Common Expenses, and subject to all of the terms, conditions, covenants, restrictions, uses, limitation and obligations under this Declaration and By-Laws, and, provided, further, that the holder of any such junior encumbrance shall release its security interest in any Unit for the purposes of restoring any Improvements upon the encumbered Condominium Unit and all of the Unit Owner(s) rights, title and interest in and to the proceeds under all insurance policies upon said premises by the Association. Such release shall be furnished forthwith by a junior mortgagee upon written request of the Association, and if such request is not granted, such release may be executed by the Association as attorney-in-fact for such junior mortgagee.

ARTICLE IX - INSURANCE - DAMAGE, DESTRUCTION AND RECONSTRUCTION

9.1 Scope of Coverage. Commencing not later than the date of the first conveyance of a Unit to a Purchaser, the Association shall maintain, to the extent reasonably available, the following insurance coverage:

(a) Property insurance on the Common Elements, Limited Common Elements and Units, exclusive of any improvements and betterments installed in Units by the Owners thereof, and other than the original improvements and betterments installed or constructed within any Unit by the Declarant (which shall be covered by the Association's insurance), insuring against all risk of direct physical loss commonly insured against in an amount equal to the maximum insurable replacement value of the Common Elements, Limited Common Elements and Units, as determined by the Board of Directors; provided, however, that the total amount of insurance after application of any deductibles shall not be less than one hundred percent (100%) of the current replacement cost of the insured property, exclusive of land, excavations, foundations and other items normally excluded from a property policy.

(b) Comprehensive general liability insurance, including medical payments insurance, in an amount determined by the Board of Directors, but not less than One Million Dollars (\$1,000,000.00) per injury or injuries, including death, arising out of a single occurrence, and Fifty Thousand Dollars (\$50,000.00) property damage; or, in the alternative, a liability policy affording coverage for bodily injury and property damage with a combined single limit in an amount not less than One Million Fifty Thousand Dollars (\$1,050,000.00). The policy or policies shall cover the Association, the Association's Board of Directors and the officers of the Association, committee members, all agents and employees of the Association and all Owners and other Persons entitled to occupy any Unit or other portion of the Condominium Unit for occurrences commonly insured against, arising out or in connection with the use, ownership or maintenance of the Common Elements, Limited Common Elements, or other portion of the Condominium which the Association has the responsibility to maintain and shall also include hired automobile and non-owned automobile coverage with cost liability endorsements to cover liabilities of the Owner.

(c) Fidelity insurance coverage for anyone who either handles (or is responsible for handling) funds that it holds or administers, regardless of whether that individual receives

compensation for services. Such policy shall provide that it may not be cancelled or substantially modified without at least ten (10) days prior written notice to the Association and any Eligible Mortgagees.

(d) Such other insurance as the Association shall determine from time to time to be appropriate to protect the Association or the Owners.

(e) The insurance policies purchased by the Association, to the extent reasonably available, shall contain the following provisions:

- (i) Each Owner shall be an insured under the policy with respect to liability arising out of his ownership of an undivided interest in the Common Elements or their membership in the Association.
- (ii) There shall be no subrogation with respect to the Association, its agents, servants, and employees, or with respect to the Owners and members of their household. Each party hereby waives, releases and discharges any right of subrogation against the other for any loss arising out of damage to or destruction of all or any portion of the Property or contents thereof when such loss is caused by any perils included within either party's insurance provisions.
- (iii) No act or omission by any Owner, unless acting within the scope of their authority on behalf of the Association, shall void the policy or be a condition to recovery on the policy.
- (iv) The coverage afforded by such policy shall not be brought into contribution or proration with any insurance which may be purchased separately by Owners or their mortgagees or beneficiaries under deeds of trust.
- (v) A "severability of interest" endorsement which shall preclude the insurer from denying the claim of an Owner because of the negligent acts of the Association or other Owners.
- (vi) Statement of the name of the insured as Park Plaza Condominium Association, Inc., for the use and benefit of the individual Owners (designated by name if required by the insurer).

(vii) For policies of hazard insurance a standard mortgagee clause providing that the insurance carrier shall notify the Qualified Lender named in the policy at least ten (10) days in advance of the effective date of any reduction or cancellation of the policy.

(viii) "Agreed Amount" and "Inflation Guard" endorsements.

It shall be the duty of the Board at least annually to conduct an insurance review to determine if the policy enforced is adequate to meet the need of the Association and to satisfy the requirement of this Declaration and the Act. Such responsibility may be performed and shall be deemed reasonably performed, by the Board's Managing Agent requesting the Association's insurance agent to verify that the insurance policies in existence meet the needs of the Association as set forth herein and satisfies the requirements of this Declaration and the Act. In all events, each Owner shall have the right to obtain additional coverage for such improvements, or betterments or personal property within the Unit as its own expense. Each policy may contain reasonable deductibles and the amount thereof shall be added to the face amount of the policies in determining whether the insurance equals at least full replacement cost.

9.2 Certificate of Insurance. An insurer that has issued an insurance policy under this Article shall issue certificates or a memorandum of insurance to the Association and, upon request, to any Owner, mortgagee or beneficiary under a deed of trust. Any insurance obtained pursuant to this Article may not be canceled until thirty (30) days after notice of the proposed cancellation has been mailed to the Association, each Owner and each Eligible Mortgagee in the insurance policy.

9.3 Payment of Premiums. Premiums for all insurance obtained by the Association pursuant to this Article shall be Common Expenses and shall be paid for by the Association.

9.4 Insurance Obtained by Owners. The issuance of insurance policies to the Association pursuant to this Article shall not prevent an Owner from obtaining insurance for their own benefit and at their own expense covering their Unit, personal property and providing personal liability coverage.

9.5 Payment of Insurance Proceeds. Any loss covered by property insurance obtained by the Association in accordance with this Article shall be adjusted by the Association and the insurance proceeds shall be payable to the Association and not to any mortgagee or beneficiary under a deed of trust. The Association shall hold any insurance proceeds in trust for Owners and lienholders as their interests may appear. Subject to the provisions of Section 9.6 and 9.7 of this Article, the proceeds shall be disbursed for the repair or restoration of the damage to Common Elements, Limited Common Elements and Units. Owners and lienholders shall not be entitled to receive payment of any portion of the proceeds unless there is a surplus of record after the Common Elements, Limited Common Elements and Units have been completely repaired or restored, or the Declaration terminated.

9.6 Use of Insurance Proceeds. In the case of fire or any other casualty, the insurance proceeds, if sufficient to reconstruct any Improvements so damaged or destroyed, shall be applied to such reconstruction. Reconstruction of the Improvements, as used herein, means restoring the insured Improvements to substantially the same condition in which it existed prior to the fire or other disaster, with each Unit and the Common Elements having the same vertical and horizontal boundaries as before.

9.7 Procedure where Insurance Proceeds are Insufficient. In case of fire or other casualty, if the insurance proceeds are insufficient to reconstruct the Improvements and the Condominium Unit Owners and all other parties in interest do not voluntarily make provision for reconstruction of the Improvements within 180 days from the date of damage or destruction, the Association may record a notice setting forth such facts; and upon the recording of such notice:

(a) The Property shall be deemed to be owned as tenants-in-common by the Condominium Unit Owners;

(b) The undivided interest in the Property owned in common of each Condominium Unit Owner shall be the percentage of undivided interest previously owned by such Unit Owner in the Common Elements;

(c) Any liens affecting any of the Condominium Units shall be deemed to be transferred in accordance with the existing priorities to the undivided interest of the Condominium Unit Owner in the Property as provided herein; and

(d) The Property shall be subject to an action for partition at the suit of any Condominium Unit Owner, in which event the net proceeds of such sale, together with the net proceeds of the insurance on the Property, if any, shall be considered as one fund, and shall be divided among all the Condominium Unit Owners in a percentage equal to the percentage of undivided interest owned by each Unit Owner in the Property, but only after first paying out of the respective share of each Condominium Unit Owners, (to the extent sufficient for the purpose) all liens on the undivided interest in the Property owned by such Condominium Unit Owner.

9.8 Insurance Deductibles. If maintenance is required as a result of an insured loss, the amount of the deductible shall be considered a maintenance expense to be paid by the Person or Persons who would be responsible for such repair in the absence of insurance. If the loss affects more than one (1) Unit, or a Unit and Common Elements, the cost of the deductible may be apportioned equally by the Board of Directors among the parties suffering loss in accordance with the total cost of repair.

ARTICLE X - MORTGAGES

10.1 Requirements.

(a) Any mortgage or other lien on a Unit and the obligations secured thereby shall be deemed to provide, generally, that the mortgage or other lien instrument and the rights and obligations of the parties thereto shall be subject to the terms and conditions of the Act and this Declaration and shall be deemed to provide specifically, but without limitation, that the mortgagee or lien holder shall have no right (i) to participate in the adjustment of losses with insurers or in the decision as to whether or not, how to repair or restore damage to or destruction of the Property, or (ii) to receive or apply the proceeds of insurance to the reduction of the mortgage debt or otherwise, except in the event and to the extent either of a distribution of such proceeds to Unit Owners pursuant to Section 76-871 of the Act or of insurance proceeds in excess of the cost of repair or restoration being received by the Owner of the Unit encumbered by such mortgage; or (iii) to accelerate the mortgage debt or to have any other remedies by virtue of waste or alleged waste or other conditions occurring anywhere on the Property other than within the affected Unit, and the obligation secured shall be pre-payable, without penalty, upon the happening of any termination of the Condominium or determination not to restore or replace the affected Unit. Nothing contained in

Section 10.1(a) hereinabove or elsewhere in this Declaration shall give a Unit Owner, or any other party, priority over any rights of the mortgagee of a Unit pursuant to its mortgage in case of a distribution to such Unit Owner of insurance proceeds or condemnation awards for loss to or a taking of one or more Units and/or Common Elements.

(b) No Unit Owner or purchaser of a Unit shall deliver any mortgage or other lien instrument secured by a Unit, or any obligation to be secured thereby, unless it has first notified the Board of the name and address of the proposed mortgagee or lien holder, the amount of the debt proposed to be so secured, and has submitted to the Board a copy of the form of the proposed mortgage and note or other instrument of obligation. When a mortgage other than (i) a first mortgage or (ii) a junior mortgage to the Declarant or Seller of a Unit is delivered to the Board, the Board shall promptly notify the proposed mortgagee whether such mortgagee has been approved by the Board as a Qualified Lender.

10.2 Qualified Lenders.

(a) When a mortgage is delivered to a Qualified Lender or other lien holder, the Unit Owner shall simultaneously provide executed or conformed copies to the Board. Upon receipt of such copy of a mortgage or other lien, the Secretary of the Board shall instruct the insurer of the property to add the name of the Qualified Lender or other lien holder to the mortgagee loss payable provision of the hazard insurance policy covering the property and to provide such Qualified Lender or other lien holder with a Certificate of Insurance showing that the Qualified Lender's or other lien holder's name has been so added.

(b) The Secretary shall maintain a register of Qualified Lender showing the names and addresses of the Qualified Lender, the amount secured by each Qualified Lender, and whether such amount secured is a first mortgage.

10.3 Rights of Qualified Lenders.

(a) Upon the specific written request of an Eligible Mortgagee on a Unit or its servicer to the Board, the mortgagee shall be entitled to receive some or all of the following as designated in the request;

- (i) Copies of budgets, notices of assessment, or any other notices or statements provided under this Declaration by the Board to the Owner of the Unit covered by the mortgage;
- (ii) Any audited or unaudited financial statements of the Board which are prepared for the Board and distributed to the Unit Owners. The holder of any mortgage on a Unit shall be entitled to obtain an audited statement at its own expense, if one is not otherwise available;
- (iii) Copies of notices of meetings of the Unit Owners and the right to be represented at any such meetings by a designated representative;
- (iv) Notice of substantial damage to or destruction of any Unit or Units that are subject to any mortgage (in excess of \$1,000) or any part of the Common Elements (in excess of \$10,000);
- (v) Notice of the commencement of any condemnation or eminent domain proceedings with respect to any part of the Property;
- (vi) Notice of any default of the Owner of the Unit which is subject to the mortgage, where such default is not cured by the Unit Owner after the giving of notice by the Association to the Unit Owner of the existence of the default within any applicable cure period;
- (vii) Any lapse, cancellation or material modification of any insurance policy or fidelity bond maintained by the Association;
- (viii) Notice of any decision by the Executive Board to terminate professional management and assume self-management of the Property;
- (ix) Any condemnation or casualty loss that affects either a material part of the Condominium or the Unit securing the Qualified Lender's mortgage;
- (x) Such other financial data as such Qualified Lender shall reasonably request; or
- (xi) Any proposed action which would require the consent of a specified percentage of first mortgagees as set forth in Section 12.2, below.

(b) The request of a Qualified Lender or its servicer shall specify which of the above items it desires to receive and shall indicate the address to which any notices or documents shall be sent by the Board. The Board need not inquire into the validity of any request made hereunder by a Qualified Lender. The Board may refuse to honor any request where, after reasonable inquiry, it shall determine that the person making such request is not entitled to the material so requested and may establish reasonable rules to implement this Section 10.3(b).

(c) Failure to comply with the requirements set forth above shall in no way invalidate the otherwise proper actions of the Association and the Board.

(d) Any Qualified Lender shall have the right, exercisable upon written request to the Board, to examine the books and records of the Association at any reasonable time and with the payment of a reasonable fee established by the Board from time to time.

ARTICLE XI - MISCELLANEOUS PROVISIONS

11.1 Effective Covenants. Each Purchaser and each grantee of Declarant, its successors and assigns, by the acceptance of a deed of conveyance, each Purchaser, accept the conveyed Property subject to all restrictions, conditions, covenants, reservations, options, liens and charges, and the jurisdiction, rights and powers granted or reserved by this Declaration or to which this Declaration is subject, and all rights, benefits and privileges of every character hereby granted, created, reserved or declared and all impositions and obligations hereby imposed shall be deemed and taken to be covenants running with the land and shall bind any Person having at any time any interest of estate in said Property, and shall inure to the benefit of such Condominium Unit Owner in like manner as though the provisions, terms and restrictions of this Declaration were received and stipulated at length in each and every deed of conveyance.

11.2 Waiver. No covenant, restriction, condition or provision of this Declaration or in the By-Laws shall be deemed to have been abrogated or waived by reason on any failure to enforce the same at any time, irrespective of the number of violations or breaches which may occur.

11.3 Savings Clause. The invalidity of any covenant, restriction, condition, limitation or any other provision of this Declaration and By-Laws herein contained, as the case may be, shall not render the remainder of the Declaration invalid, nor any other part therein contained.

11.4 Controlling Instrument. In the event of a conflict between the provisions of this Declaration and the By-laws, this Declaration shall prevail except to the extent that this Declaration is inconsistent with the Act.

ARTICLE XII - AMENDMENT AND TERMINATION

12.1 Amendments; Modifications and Terminations.

(a) The prior written approval of a Super-Majority Vote of the Unit Owners and at least sixty-seven percent (67%) of the votes of the holders of Eligible Mortgages of Units (based upon one (1) vote for each mortgage owned) shall be required to:

- (i) Terminate the condominium status of the Property for reasons other than substantial destruction or condemnation of the Property;
- (ii) Abandon, encumber, sell or transfer any Common Elements (the granting of easements for public utilities or for other public purposes consistent with the intended uses of the Common Elements shall not be deemed a transfer within the meaning of this subsection); or
- (iii) The use of hazard insurance proceeds for losses to any Condominium Property (whether to Units or to Common Elements) for other than the repair, replacement or reconstruction of such Condominium Property.

(b) The prior written approval of a Super-Majority Vote of the Unit Owners and at least fifty-one (51%) percent of the holders of Eligible Mortgages of Units shall be required to make an amendment of a material nature to the Condominium Documents. A change in the provisions of any Condominium Document directly relating to any of the following shall for this purpose be considered material:

- (i) A change in the schedule of Allocated Interests or a change in the schedule of Limited Common Element Allocations set forth in Exhibit "C" allocated to each Unit;
- (ii) Voting rights;
- (iii) Increases in assessments that raise the previously assessed amount by more than twenty-five (25%) percent, or the priority or the subordination of assessment liens;

- (iv) Reductions in reserves for maintenance, repair and replacement of the Common Elements;
- (v) Responsibility for maintenance and repairs;
- (vi) Reallocation of interests in the Common Elements or Limited Common Elements or rights to their use;
- (vii) Convertibility of Units into Common Elements or of Common Elements into Units;
- (viii) Expansion or contraction of the Condominium or the addition, annexation or withdrawal of property to or from the Condominium;
- (ix) Insurance or fidelity bond requirements;
- (x) Change of restrictions on the leasing of any Units;
- (xi) Imposition of any restrictions of a Unit Owner's right to sell or transfer his or her Unit;
- (xii) A decision by the Association to establish self-management if any professional management had been required previously by a Qualified Lender;
- (xiii) Restoration or repair of the Condominium (after a hazard damage or partial condemnation) in a manner other than that specified in the Condominium Documents;
- (xiv) Actions to terminate the legal status of the Condominium after substantial destruction or condemnation occurs;
- (xv) The method of assessments described in this Declaration; or
- (xvi) Provisions that expressly benefit holders, insurers or guarantors of Eligible Mortgages.

(c) Notwithstanding anything to the contrary in Section 12.1, written approval of Eligible Mortgagees or Qualified Lenders of Units shall not be required for an amendment to this Declaration made pursuant to Section 12.3, below.

12.2 Approval of Mortgagees. The approval rights granted to Qualified Lenders above shall be subject to the limitations imposed by Section 76-856 of the Act. In addition, if any

Eligible Mortgage Holder or Qualified Lender fails to cast a vote pursuant to Sections 12.1(a) or 12.1(b), above, within ten (10) business days after receipt of notice, such Eligible Mortgage Holder or Qualified Lender will conclusively be deemed to have voted in favor of such amendment, modification or termination.

12.3 Amendments by Declarant Only. Notwithstanding the foregoing or anything elsewhere contained herein, the Declarant shall have the right acting alone and without the consent or approval of the Owners, the Association, the Board of Directors, any Mortgagees or any other person at any time during the Period of Declarant Control to amend or supplement this Declaration from time to time if (i) such amendment or supplement is necessary to conform this Declaration to the Act, as amended from time to time, or (ii) such amendment or supplement is made to implement expansion of the Property pursuant to Special Declarant rights reserved herein, or (iii) such amendment is necessary to comply with requirements of the Federal National Mortgage Association, the Government National Mortgage Association, the Federal Home Loan Mortgage Corporation, the Department of Housing & Urban Development, the Federal Housing Association, the Veteran's Administration or any other governmental agency or any other public, quasi-public or private entity which performs (or may in the future perform) functions similar to those currently performed by such entities, or (iv) such amendment is necessary to correct clerical or typographical errors or to clarify Declarant's original intent, or (v) such amendment as may be necessary to implement any changes in the Condominium Regime that is permitted to be made by Declarant under this Declaration.

ARTICLE XIII - DECLARANT RIGHTS

13.1 Development Activities. During the Period of Declarant Control, notwithstanding any provision herein to the contrary, the Declarant shall have the following rights and privileges, which are hereby reserved only to itself and to its successors and assigns and their respective agents:

(a) To create additional Units, Common Elements, Limited Common Elements within all or any part of the Condominium or Additional Property, which Additional Units may be designated on the Plans as Additional Units or as "Reserved" or "Reserved for Future Development"; and to add Additional Property to the Condominium, provided, however, that the maximum number of Units which the Declarant reserves the right to create shall not exceed Twenty (20) additional

Units. Upon the addition of any Units to the Condominium, the Allocated Interests shall be reallocated among all units pursuant to the terms of this Declaration and the formula set forth herein.

(b) To exercise any Special Declarant Rights provided for under the Act.

(c) To erect and maintain on the Common Elements, advertising signs, sales flags or other sales devices and banners for the purpose of aiding the sale of Units in the Condominium, and to maintain sales and business offices in at least one Unit or in any Common Element or building in this Condominium to facilitate the completion of construction of the Improvements comprising this Condominium, apartments and homes now or hereafter constructed within said development and sale of the Units therein contained.

(d) To erect or maintain on the Common Areas any sales office facilities, either of a modular or permanent construction, in the sole discretion of the Declarant, its successors, assigns or their agents, that will aid in the sale, marketing or advertising of the Condominium Units.

The consent of Unit Owners within the Condominium shall not be required for the exercise of any of the foregoing Development Rights, and the Declarant may proceed with the exercise of such Development Rights at its sole option and its sole discretion. The option reserved to (i) relocate the boundaries of any Unit or Units, (ii) further subdivide any one or more of the Units into additional Units, Common Elements or Limited Common Elements, and (iii) annex the Additional Property, shall be exercisable by the Declarant, its successors and assigns, who shall have the unilateral right to reallocate percentages of undivided interests in the Common Elements, liability for payment of Common Expenses, allocation of Limited Common Elements, and allocation of votes in the Association, as to be done in accordance with the limitations and formulas set forth in this Declaration and the Act. The Declarant shall exercise this option by its adoption, execution or recordation of an Amendment to this Declaration by recording such certificates and plans as required by the Act. Such amendment shall be adopted by the Declarant pursuant to the terms hereof without the consent of any Unit Owners. From time to time, as the Declarant shall file permitted amendments to this Declaration adding portions of the Additional Property to the Condominium and additional common elements and each then Owner and each Person or entity thereafter becoming an Owner and its successors in title shall, upon the reallocation of such Common Elements or Limited Common Elements automatically be vested with his or her appropriate Allocated Interest computed

in accordance with the terms hereof and specifically be vested with his or her appropriate undivided percentage interest in such additional Common Elements. If the Declaration is amended as permitted herein to include Additional Property, which may include additional Units, and Owner's undivided percentage interest in the Common Elements, and Allocated Interests shall be deemed changed and reduced in accordance with the formulas and methods provide in this Declaration. With regard to any portion of the Additional Property which is not committed to this Declaration, such may be developed in ay other manner as in the total discretion of the owner of such Additional Property.

13.2 Permanent Access and Utility Easement. The Declarant reserves unto itself, its successors and assigns, a permanent easement for ingress, egress and utility purposes to any adjacent properties now or hereafter owned by Declarant, its successors and assigns as shown on the Plat and Plans.

IN WITNESS WHEREOF, the Declarant, has caused these presents to be signed by its authorized member, the day and year first above written.

DECLARANT:

PARK PLAZA, a Nebraska general partnership,

By: *[Signature]*
Its: *Partner*

STATE OF NEBRASKA)
)ss.
COUNTY OF DOUGLAS)

Before me, a notary public, in and for said county and state, personally came *Aaron Agnewell*, *Partner* of *Park Plaza*, known to me to be the identical person who executed the above instrument and acknowledged the execution thereof to be his voluntary act and deed on behalf of said general partnership.

Witness my hand and Notarial Seal this *20* day of *May*, 2005.



[Signature]

Notary Public

**CONSENT TO AND RATIFICATION
OF DECLARATION**

The undersigned hereby consents to the above and foregoing Declaration; agrees that the Property identified in Exhibit A of this Declaration shall be owned, held, transferred, sold, leased, conveyed, developed, used, occupied, operated, improved, mortgaged or otherwise encumbered subject to the provisions of this Declaration; agrees that this Declaration and all of its provisions shall be and are covenants running with the Property, and shall be binding on the undersigned, its successors and assigns; and the undersigned hereby ratifies and approves of the recordation of this Declaration in the Office of the Douglas County Register of Deeds against the Property legally described on Exhibit A.

IN WITNESS WHEREOF, the undersigned has caused this instrument to be executed this

31st day of May 2005.

LENDER:

MID STATES BANK, N.A.

By: Michael J. Kenealy
Its: President Co. Builts Location

Laura
STATE OF NEBRASKA)
R. Hawthorn) ss.
COUNTY OF DOUGLAS)

Before me, a notary public, in and for said county and state, personally came Michael J. Kenealy, President of Mid States Bank, N.A., known to me to be the identical person who executed the above instrument and acknowledged the execution thereof to be his/her voluntary act and deed on behalf of such lending institution.

Witness my hand and Notarial Seal this 31st day of May, 2005.



Rachel R. Carey
Notary Public





EXHIBIT A**REAL PROPERTY DESCRIPTION**

Lot 15 and the West half of the vacated alley adjoining to the East, and the North half of the vacated alley adjoining on the South, and lots 14, 13, and 12 and the West half of Lot 11, together with the South half of the vacated alley adjoining on the North, except the South 3 feet of said Lots taken for Street, all in Block 4, West End, an Addition to the City of Omaha, as surveyed, platted and recorded in Douglas County, Nebraska.

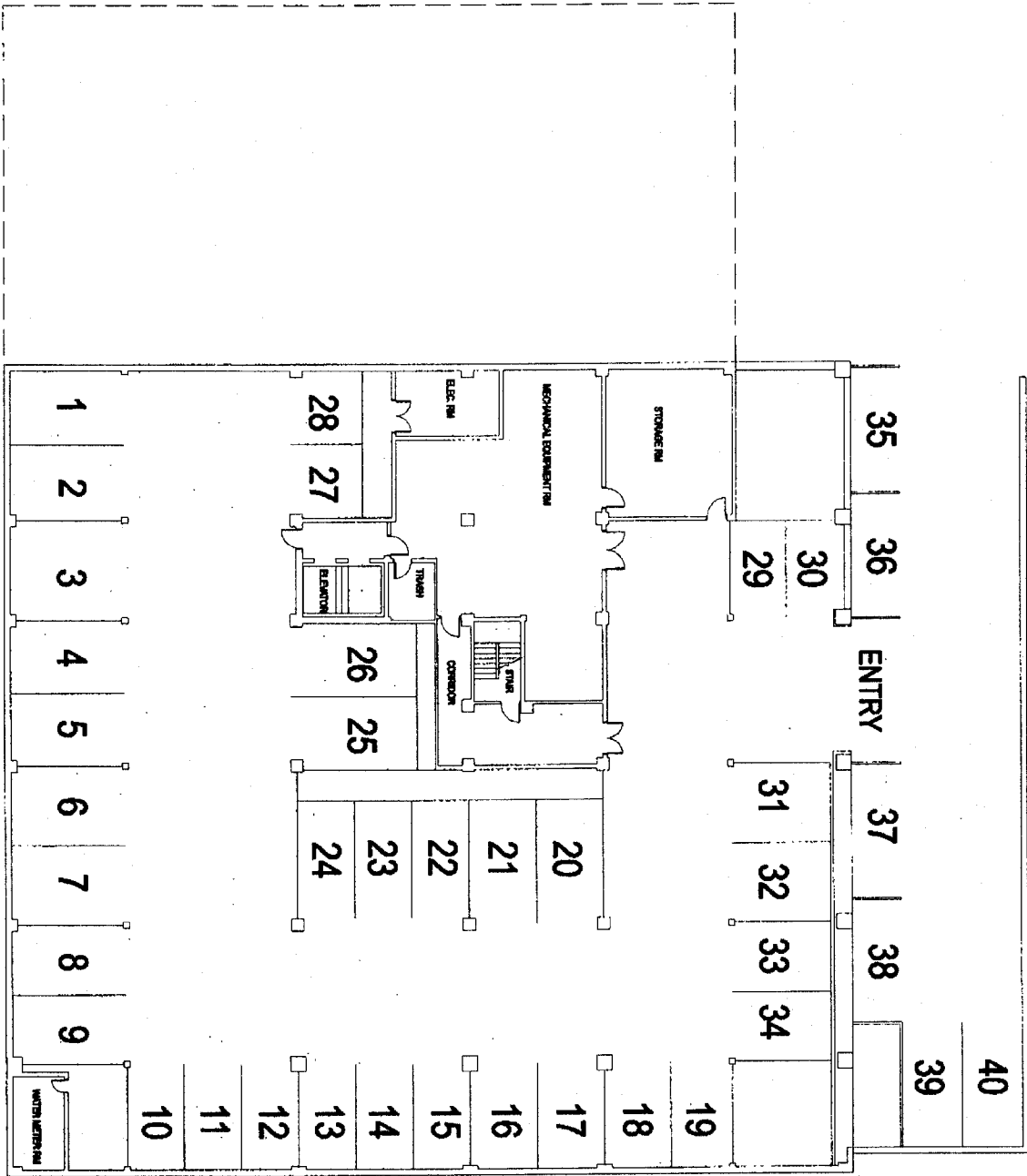
EXHIBIT "B"

PLANS



 LOWER LEVEL PARKING
 RESIDENTIAL LIMITED COMMON ELEMENTS
 COMMERCIAL LIMITED COMMON ELEMENTS
 COMMON ELEMENTS

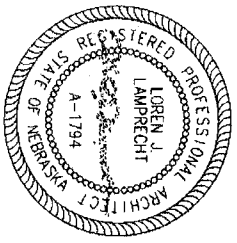

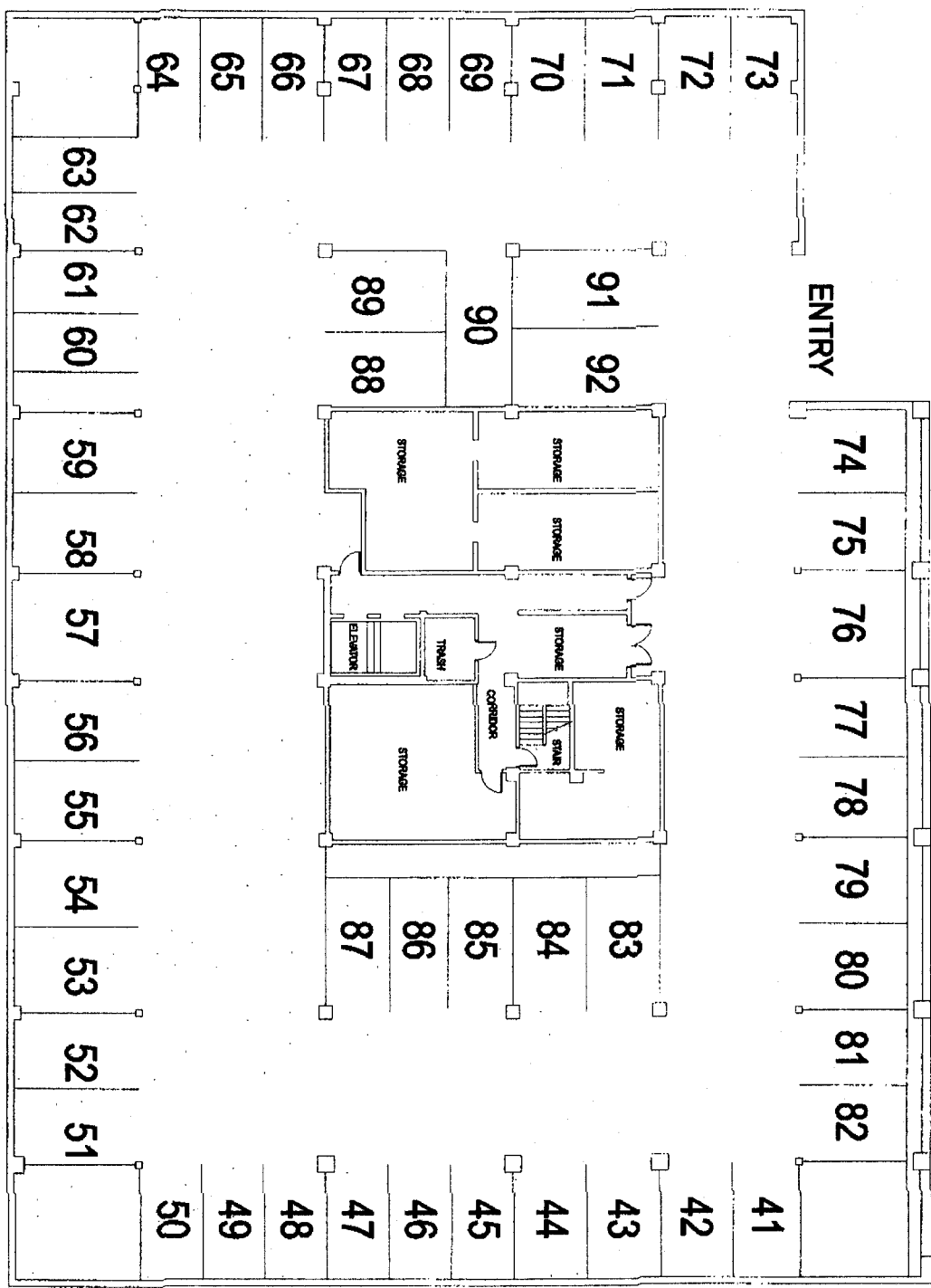

MIDDLE LEVEL PARKING

RESIDENTIAL LIMITED COMMON ELEMENTS

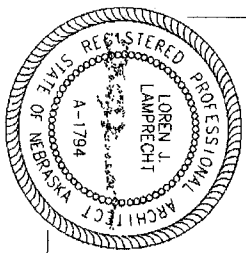

COMMERCIAL LIMITED COMMON ELEMENTS

COMMON ELEMENTS

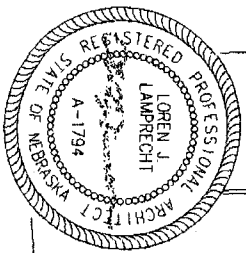





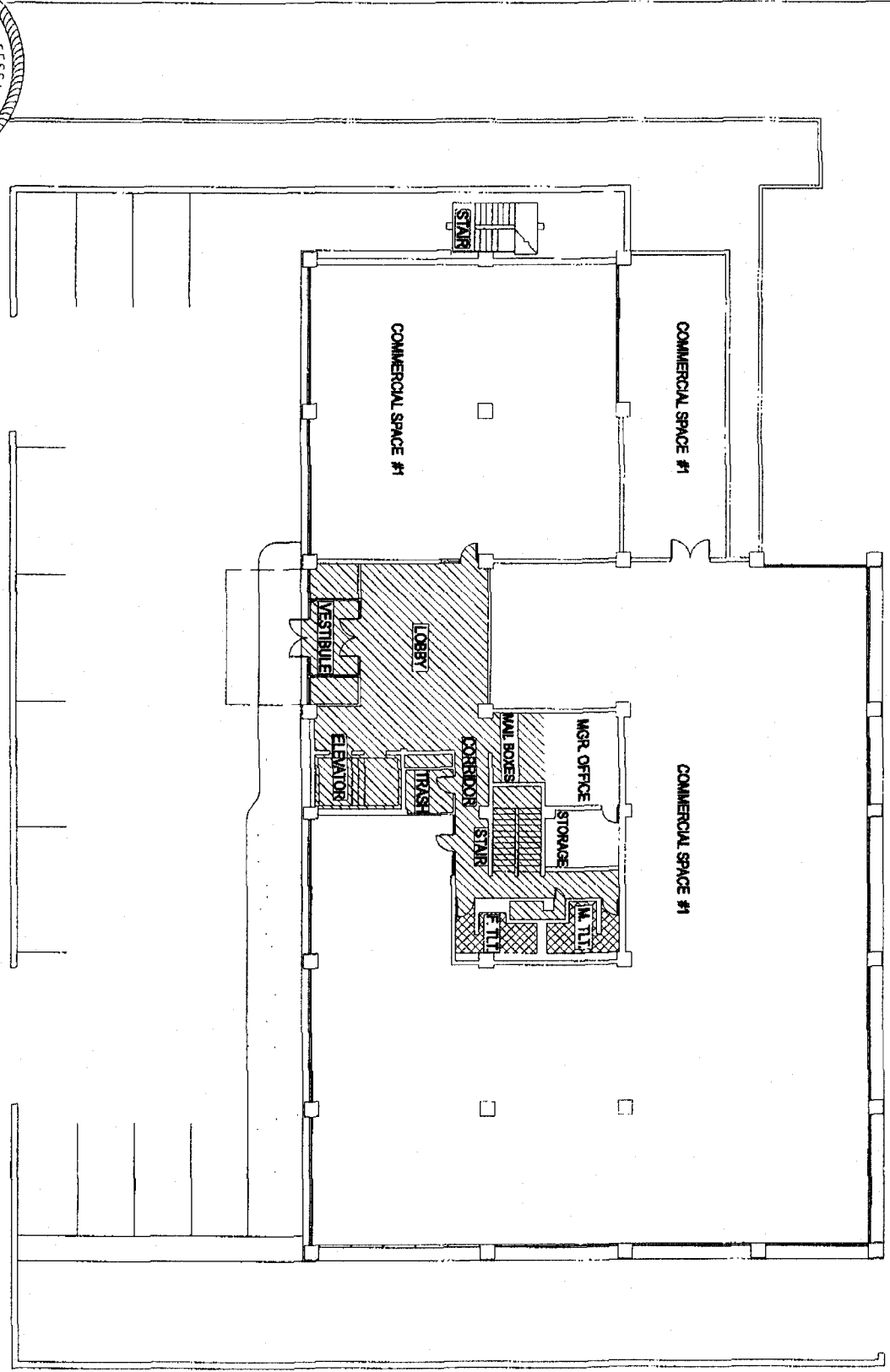

FIRST FLOOR PLAN

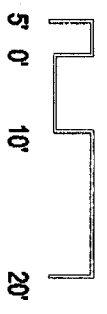
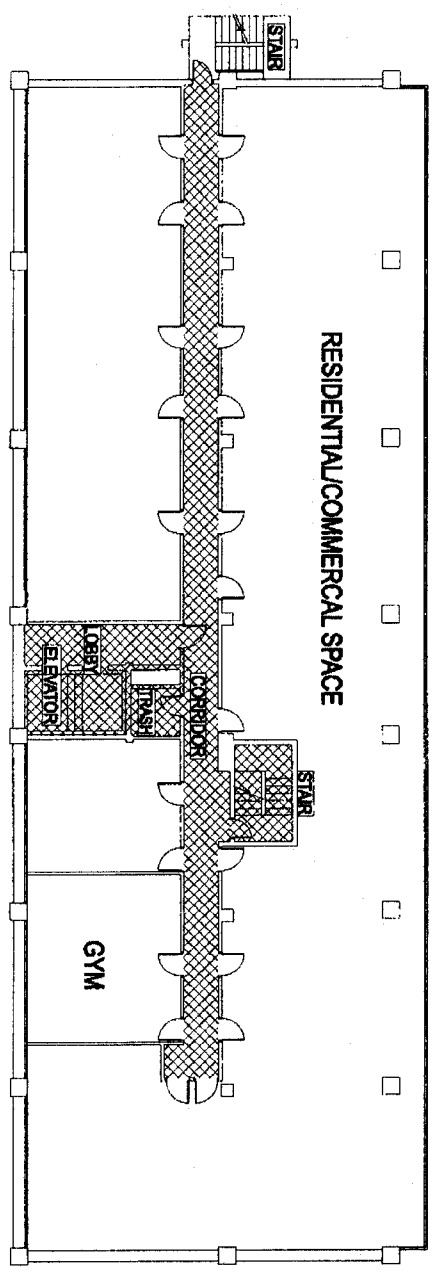
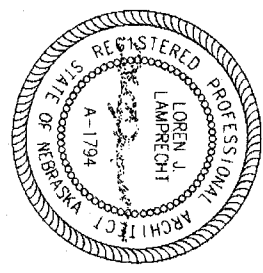
 RESIDENTIAL LIMITED COMMON ELEMENTS
 COMMERCIAL LIMITED COMMON ELEMENTS
 COMMON ELEMENTS





SECOND LEVEL PLAN

-  RESIDENTIAL LIMITED COMMON ELEMENTS
-  COMMERCIAL LIMITED COMMON ELEMENTS
-  COMMON ELEMENTS

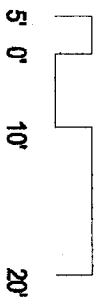
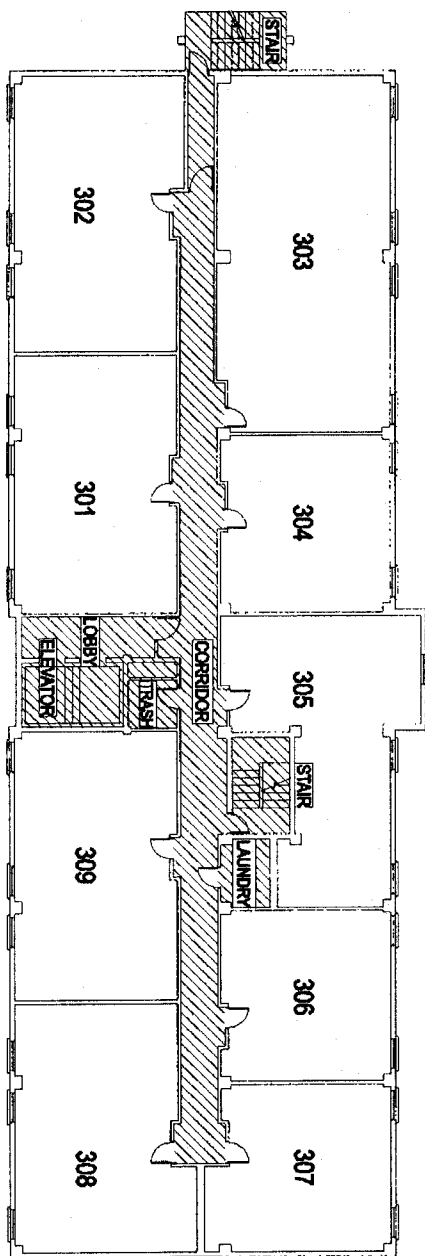
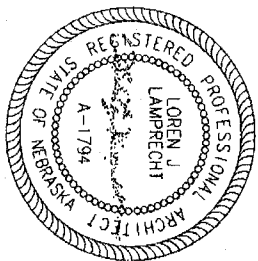

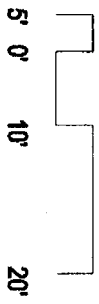
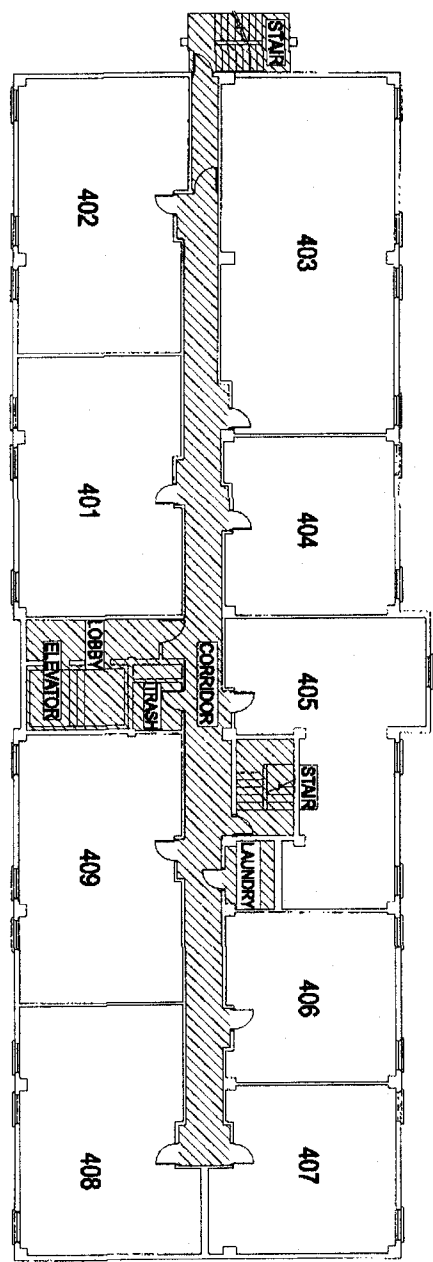
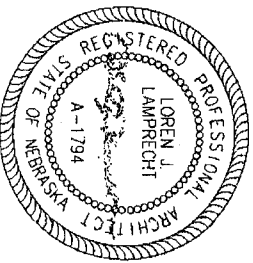

3RD FLOOR PLAN

-  RESIDENTIAL LIMITED COMMON ELEMENTS
-  COMMERCIAL LIMITED COMMON ELEMENTS
-  COMMON ELEMENTS



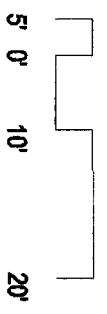
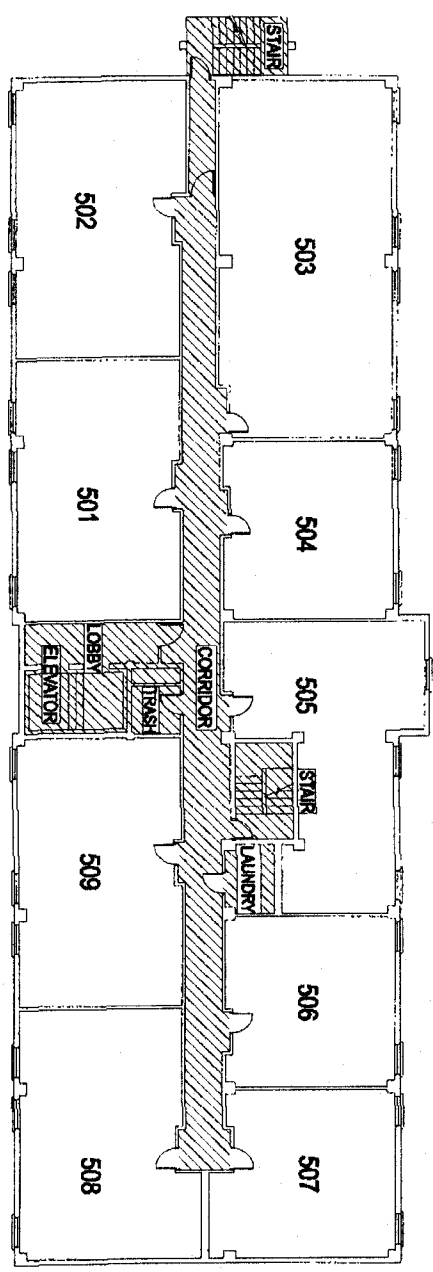
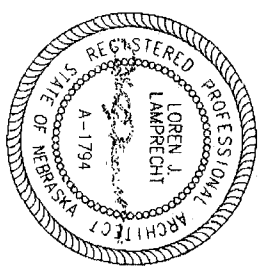

4TH FLOOR PLAN

-  RESIDENTIAL LIMITED COMMON ELEMENTS
-  COMMERCIAL LIMITED COMMON ELEMENTS
-  COMMON ELEMENTS



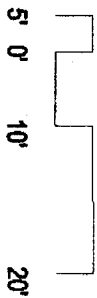
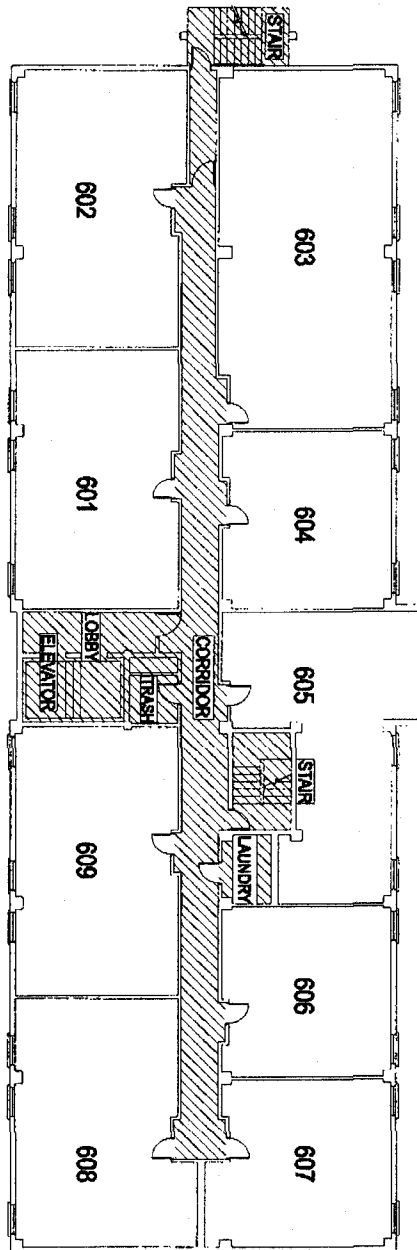
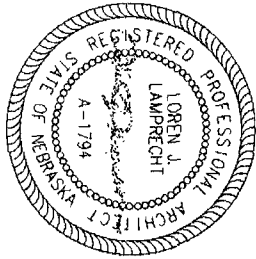

5TH FLOOR PLAN

-  RESIDENTIAL LIMITED COMMON ELEMENTS
-  COMMERCIAL LIMITED COMMON ELEMENTS
-  COMMON ELEMENTS



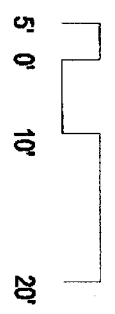
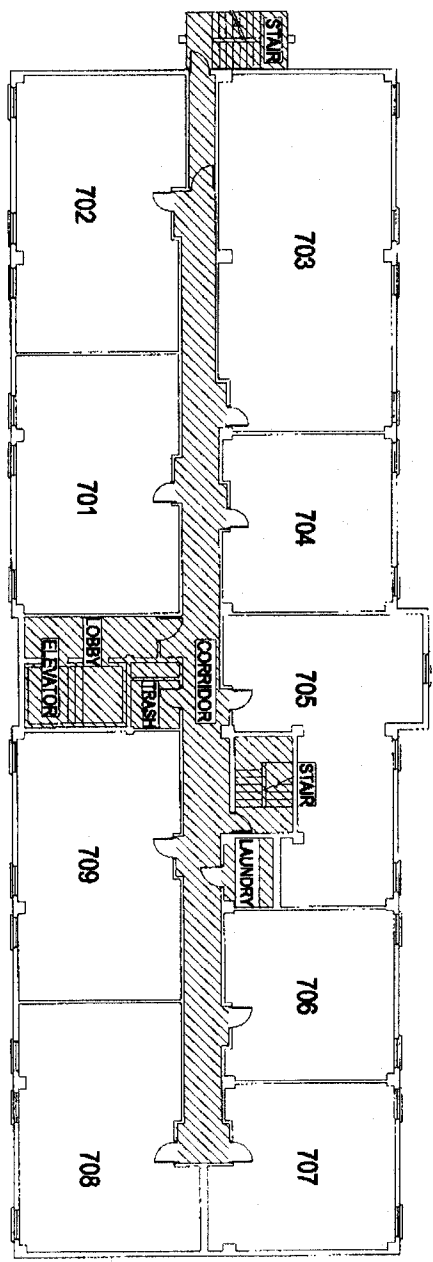
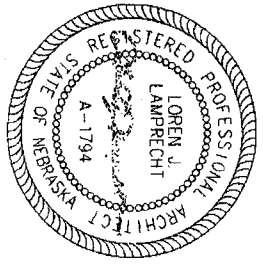

6TH FLOOR PLAN

-  RESIDENTIAL LIMITED COMMON ELEMENTS
-  COMMERCIAL LIMITED COMMON ELEMENTS
-  COMMON ELEMENTS



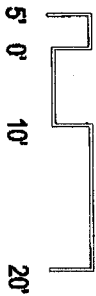
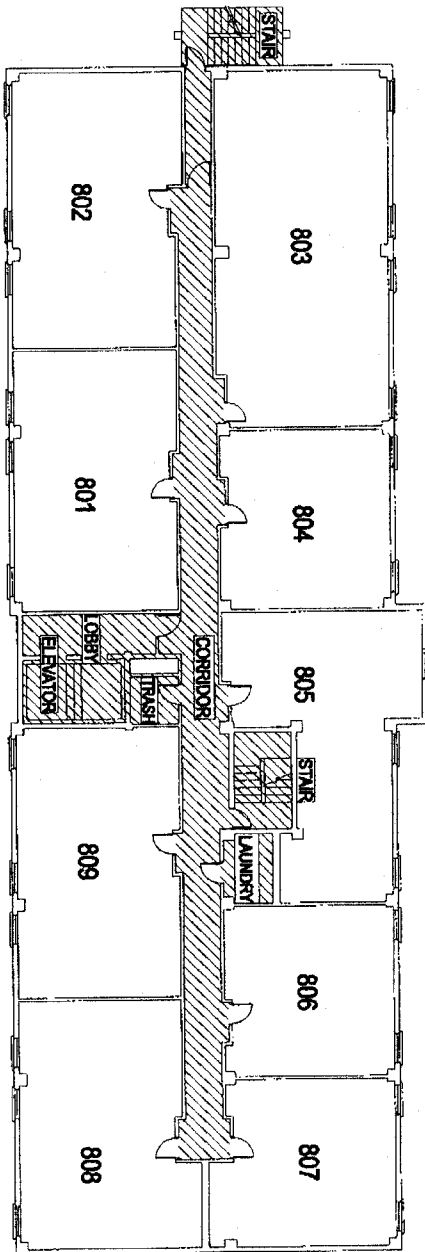
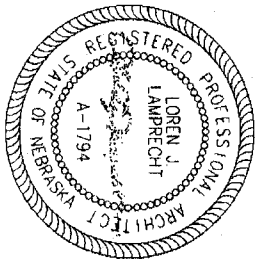

7TH FLOOR PLAN

-  RESIDENTIAL LIMITED COMMON ELEMENTS
-  COMMERCIAL LIMITED COMMON ELEMENTS
-  COMMON ELEMENTS



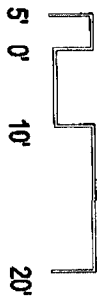
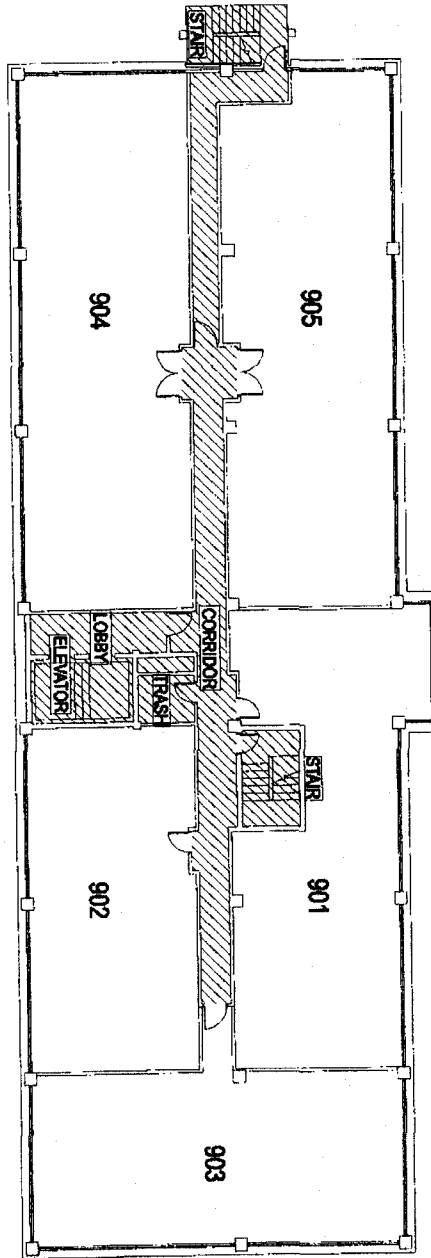
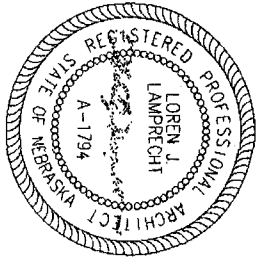

8TH FLOOR PLAN

-  RESIDENTIAL LIMITED COMMON ELEMENTS
-  COMMERCIAL LIMITED COMMON ELEMENTS
-  COMMON ELEMENTS



9TH FLOOR PLAN

-  RESIDENTIAL LIMITED COMMON ELEMENTS
-  COMMERCIAL LIMITED COMMON ELEMENTS
-  COMMON ELEMENTS

31ST AVENUE

2470R 246.85'A
152'

SOP WALL

9.8'

CONCRETE BK 101 BK 102 457



51.5
FILE
ESCAPE
15

VACATED
ALLEY

LEASEMENT
TO CITY OF OMAHA
ORD. NO. 24331

104' WIDE

158.5'

BUILDING

14
46.3

13

92'

WALL

47.85'

CONCRETE

47.83'

175'

107.43'A

CONCRETE

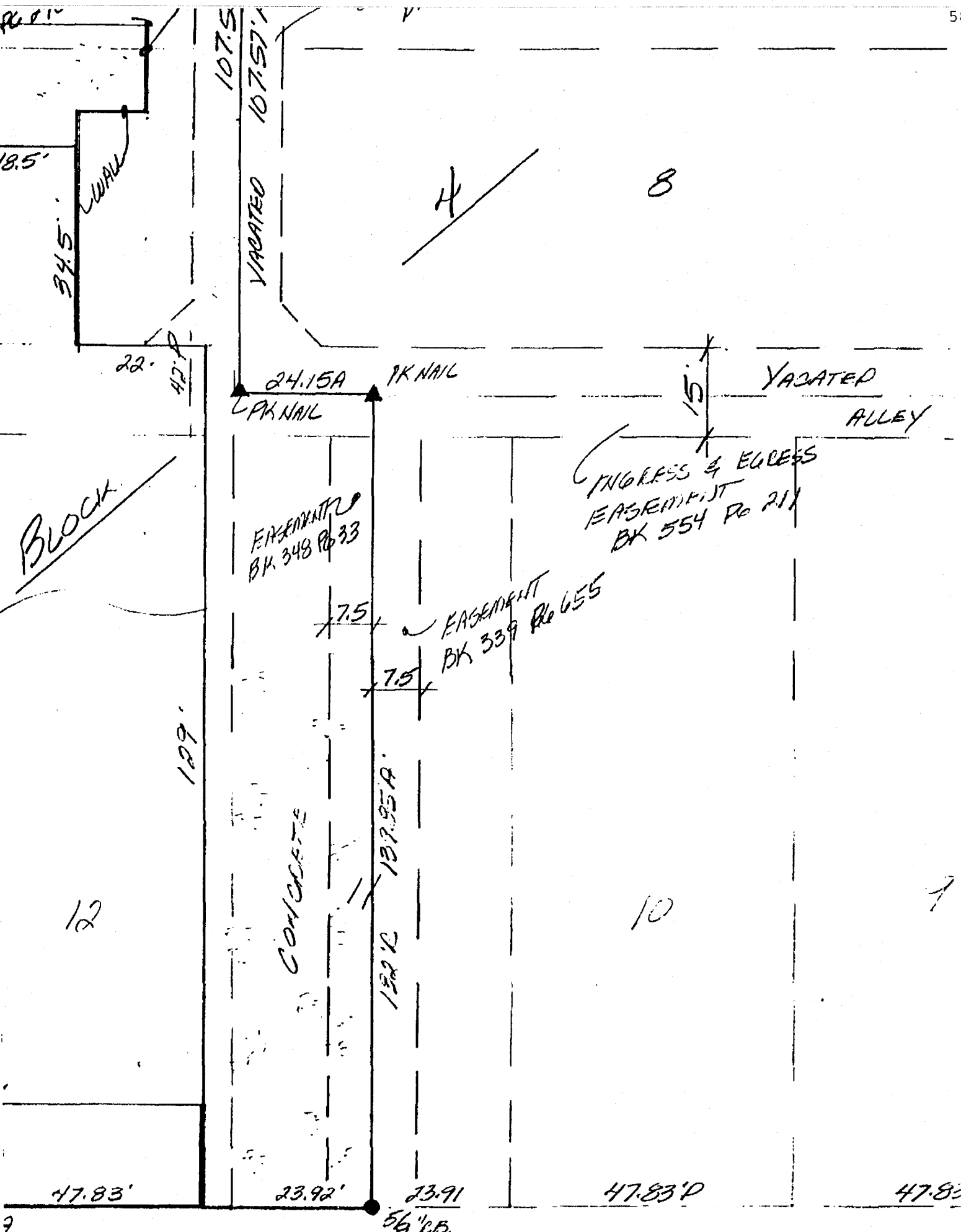

BLOCK

VACATED 107.5' 107.57'

24.15A 1PK NAIL
L PK NAIL

VACATED ALLEY

INGRESS & EGRESS
EASEMENT
BK 554 Pg 211

EASEMENT
BK 348 Pg 33

EASEMENT
BK 339 Pg 655

CONCRETE

137.95A

129'

47.83'

23.92'

23.91

47.83'

47.83'

56" DB.

4

8

12

10

7

SOUTH HALF OF THE VACATED ALLEY ADJOINING ON THE NORTH, BLOCK 4, EXCEPT THE SOUTH 3 FEET OF SAID LOTS TAKEN FOR STREET, IN WEST END, AN ADDITION TO THE CITY OF OMAHA, AS SURVEYED, PLATTED AND RECORDED IN DOUGLAS COUNTY, NEBRASKA

PARCEL 2: (ADDITIONAL PROP)

LOT 16, BLOCK 4, WEST END, AN ADDITION TO THE CITY OF OMAHA, AS SURVEYED, PLATTED AND RECORDED IN DOUGLAS COUNTY, NEBRASKA TOGETHER WITH THE WEST 1/2 OF VACATED ALLEY ADJOINING ON THE EAST

50' P

5/8" O.T

STAR DRILL HOLE

LEY

31ST STREET

130' P

CERTIFICATION

I, CLARENCE ROGER CARRELL, A REGISTERED LAND SURVEYOR DO HEREBY CERTIFY THAT THE ACCOMPANYING SURVEY REPRESENTS A TRUE AND CORRECT SURVEY MADE BY ME OR UNDER MY DIRECT SUPERVISION OF THE FOLLOWING DESCRIBED PROPERTY ON THE 20TH DAY OF JULY, 2005.

Clarence Roger Carrell

CLARENCE ROGER CARRELL

RLS 306

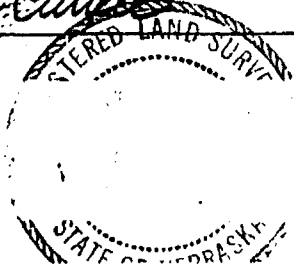

47.83' P

31ST AVENUE

STAR DRILL HOLE

143.90' A'
14350' F

ADDITIONAL PROPER
NOT PART OF PROPR

16'

128.7' PEI
EA BK
CONCRETE

50' F

4.2'

9.0'

50' WALL



51.5
FILE
ESCAPE

15

15

VACATED
ALLEY

CEASEMENT
TO CITY OF OMAHA
ORD. NO. 24331

246.35' A

247.0'

CONCRETE

158.5'

BUILDING

PARK PLAZA CONDOS

105 NO. 31ST STREET

OMAHA, NEBRASKA

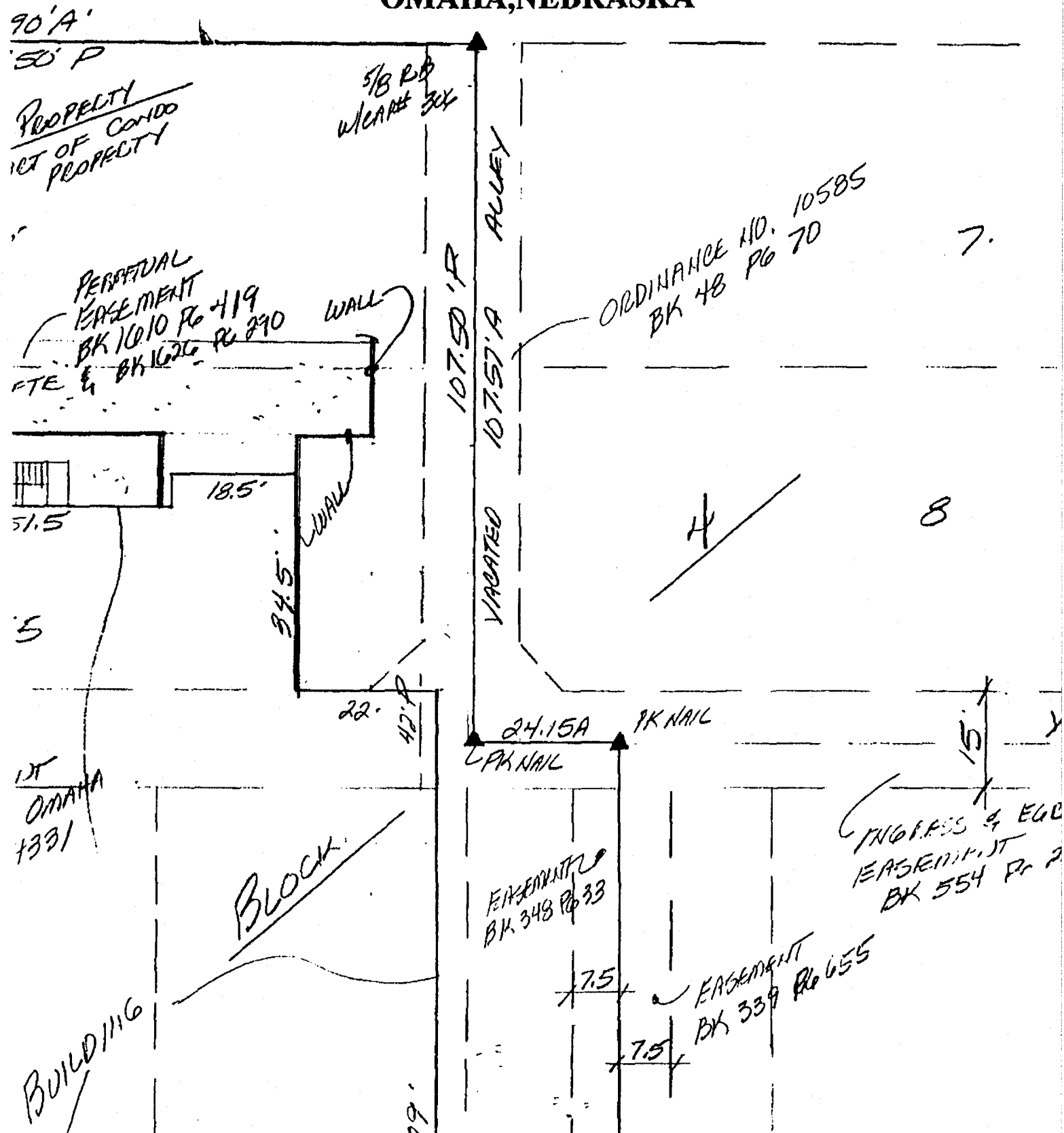

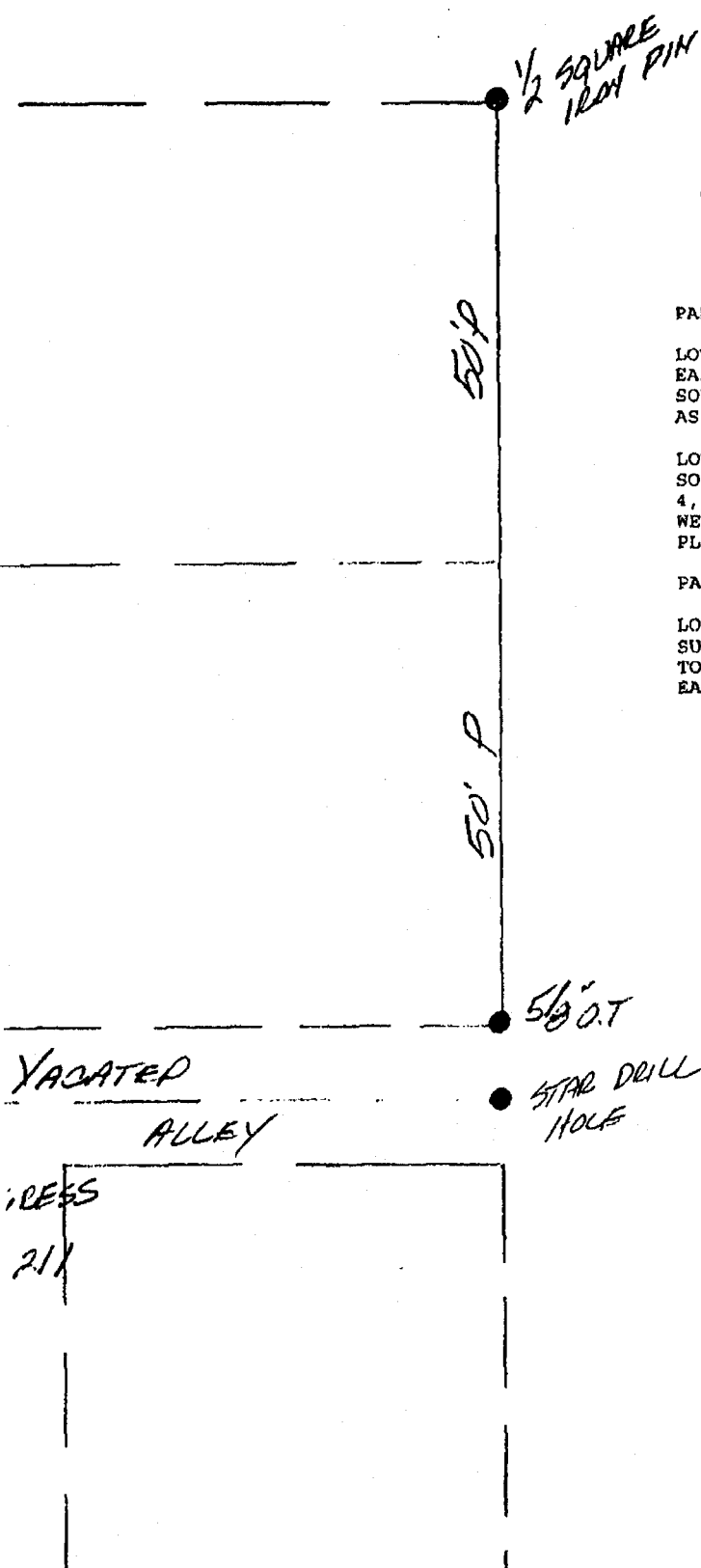

LEGAL DESCRIPTION:

PARCEL 1:

LOT 15 AND THE WEST HALF OF THE VACATED ALLEY ADJOINING ON THE EAST, AND THE NORTH HALF OF THE VACATED ALLEY ADJOINING ON THE SOUTH, BLOCK 4, IN WEST END, AN ADDITION TO THE CITY OF OMAHA, AS SURVEYED, PLATTED AND RECORDED IN DOUGLAS COUNTY, NEBRASKA

LOTS 14, 13, 12 AND THE WEST HALF OF LOT 11, TOGETHER WITH THE SOUTH HALF OF THE VACATED ALLEY ADJOINING ON THE NORTH, BLOCK 4, EXCEPT THE SOUTH 3 FEET OF SAID LOTS TAKEN FOR STREET, IN WEST END, AN ADDITION TO THE CITY OF OMAHA, AS SURVEYED, PLATTED AND RECORDED IN DOUGLAS COUNTY, NEBRASKA

PARCEL 2: (ADDITIONAL PLOP)

LOT 16, BLOCK 4, WEST END, AN ADDITION TO THE CITY OF OMAHA, AS SURVEYED, PLATTED AND RECORDED IN DOUGLAS COUNTY, NEBRASKA TOGETHER WITH THE WEST 1/2 OF VACATED ALLEY ADJOINING ON THE EAST

VACATED
ALLEY

DRESS
211

5/8" O.T.

STAR DRILL
HOLE

31ST STREET



ELEV MACHINE RM,
ROOF SLAB EL. 238'-3"

13'2"

9TH FLR, ROOF SLAB EL. 225'-11"

13'4 1/2"

8TH FLR EL. 221'-2 1/2"

13'7 1/2"

7TH FLR EL. 218'-11"

4'7"

6TH FLR EL. 235'-6"

4'7"

5TH FLR EL. 228'-11"

4'7"



ELEV. MACHINE RM.
ROOF SLAB EL. 238'-3"

9TH FLR. ROOF SLAB EL. 275'-1"

ELEV. MACH. RM. SLAB EL. 277'-7"

8TH FLR. EL. 261'-2"

7TH FLR. EL. 248'-1"

6TH FLR. EL. 235'-6"

5TH FLR. EL. 222'-11"

13'-2"

15'-4 1/2"

13'-7 1/2"

9'-7"

9'-7"

9'-7"

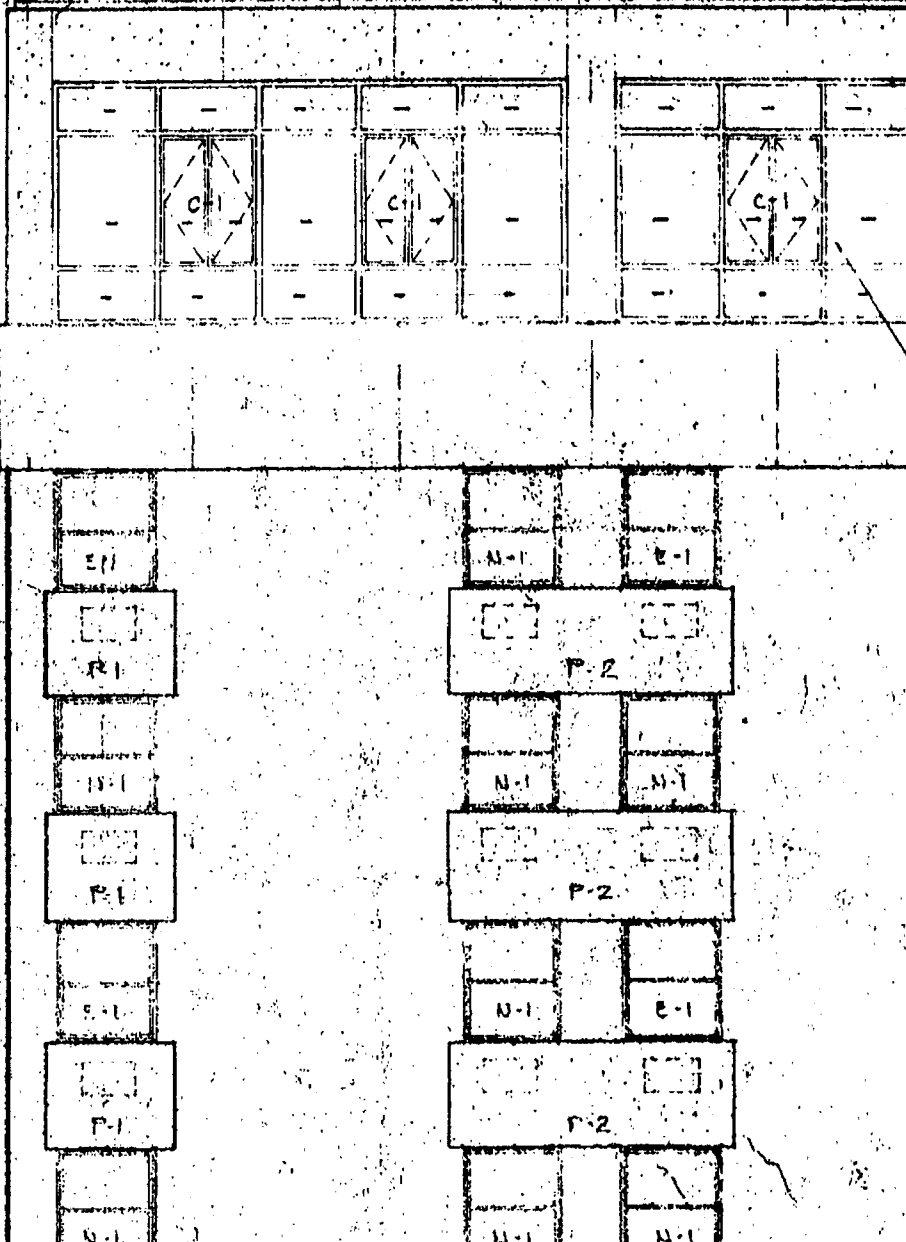

1

5

6

7

1/4" GLASSWELD PANELS

SEE S
INACT

CERAMIC
TILE

WRITE P.C. PLAST. V CONTROL JTS

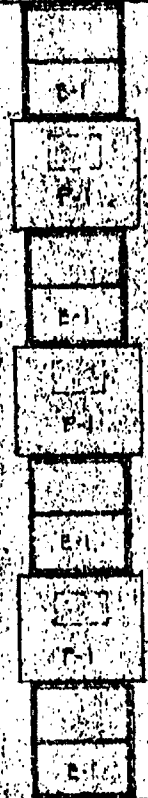
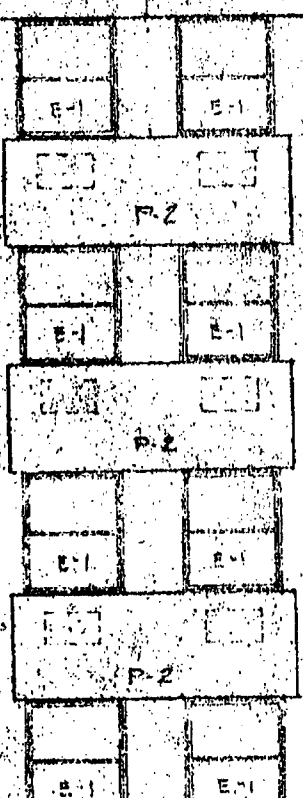

EXIT PRECAST
PANELS TO REMAIN

8

9

10

11

SEE "A-20" FOR ELEV.
H. R/W. DETAILS

2
A-5

1/4" GLASS VELD PANELS

1
A-14

WHITE P.C. PLASTER
W/ EXPANSION
BEADS AS SHOWN



TS. AS SHOWN

1/4" SPANDRELITE
GLASS PANEL

2
A-14

3
A-14

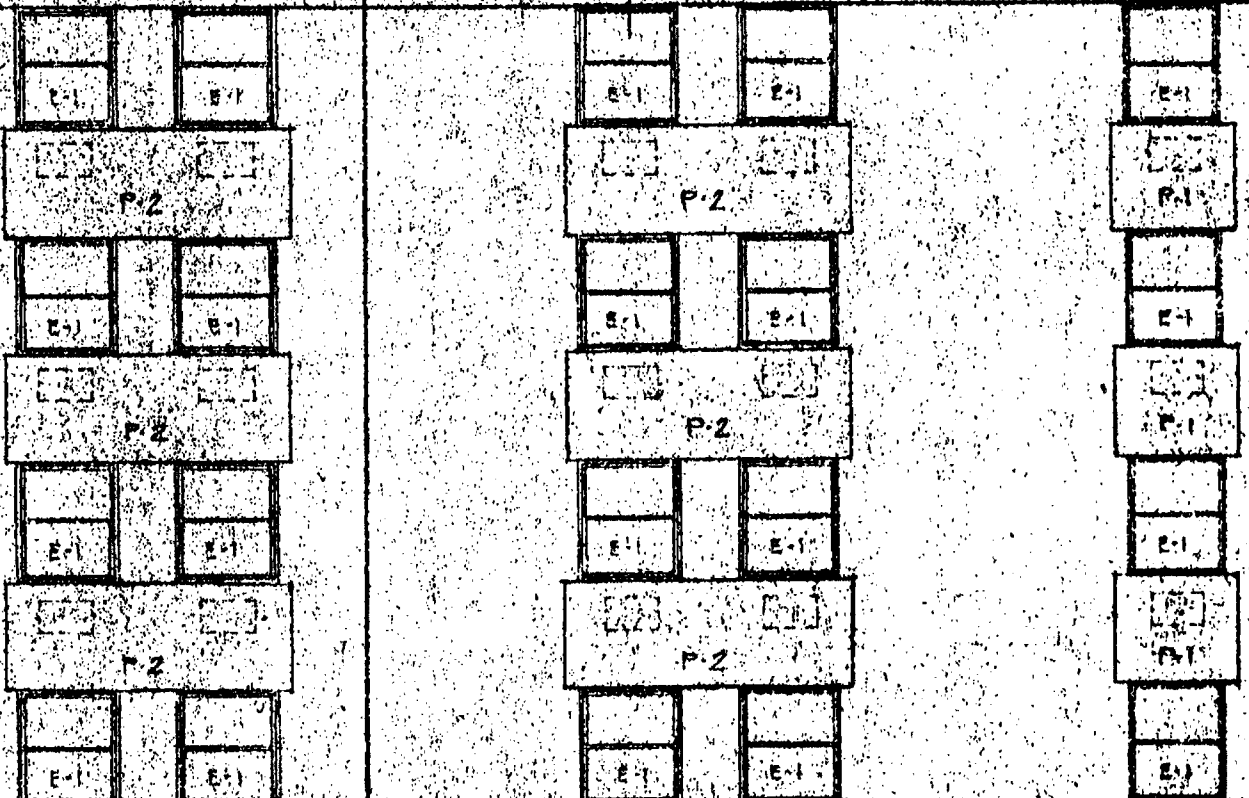

12

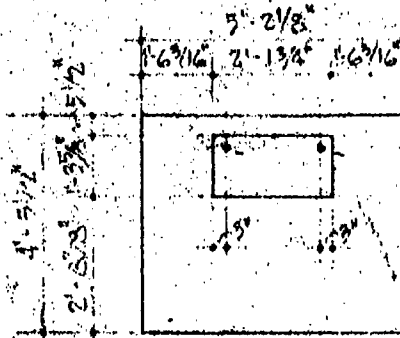

PANEL P-1

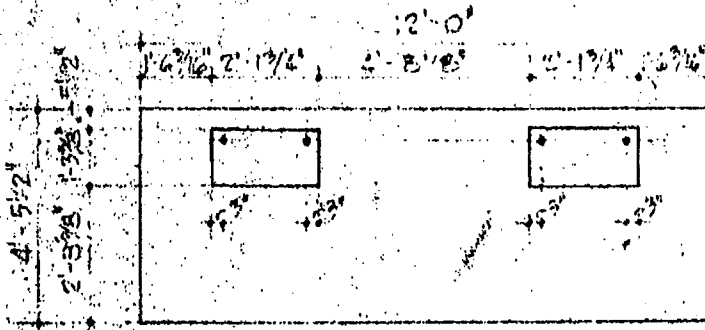

PANEL P-2

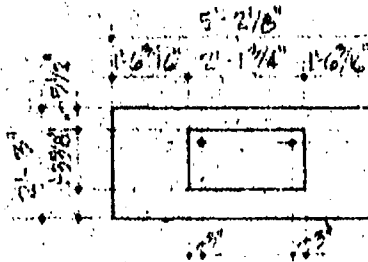

PANEL P-3

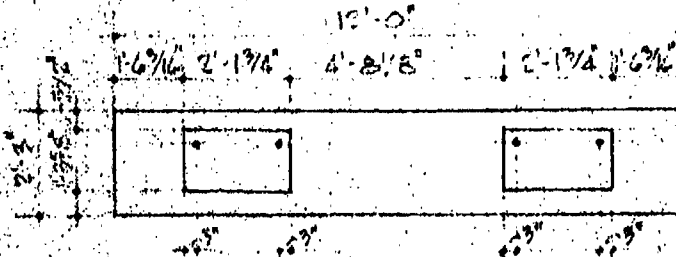

PANEL P-4



NEW PRECAST PANEL

ARCHITECTS
 & ASSOCIATES, INC.
 NEW YORK, N.Y.
 10017

7TH FLR EL 217'-4"

4TH FLR EL 209'-9"

3RD FLR EL 200'-0"

EXIST. STEEL STAIR TO REMAIN - REPAIR, COMPLETE & PAINT

2ND FLR EL 191'-8"

RAILING - SEE DET.



1ST FLR EL 169'-8"

MIDDLE LEVEL CORE EL 155'-2"

LOWER LEVEL CORE EL 144'-8"

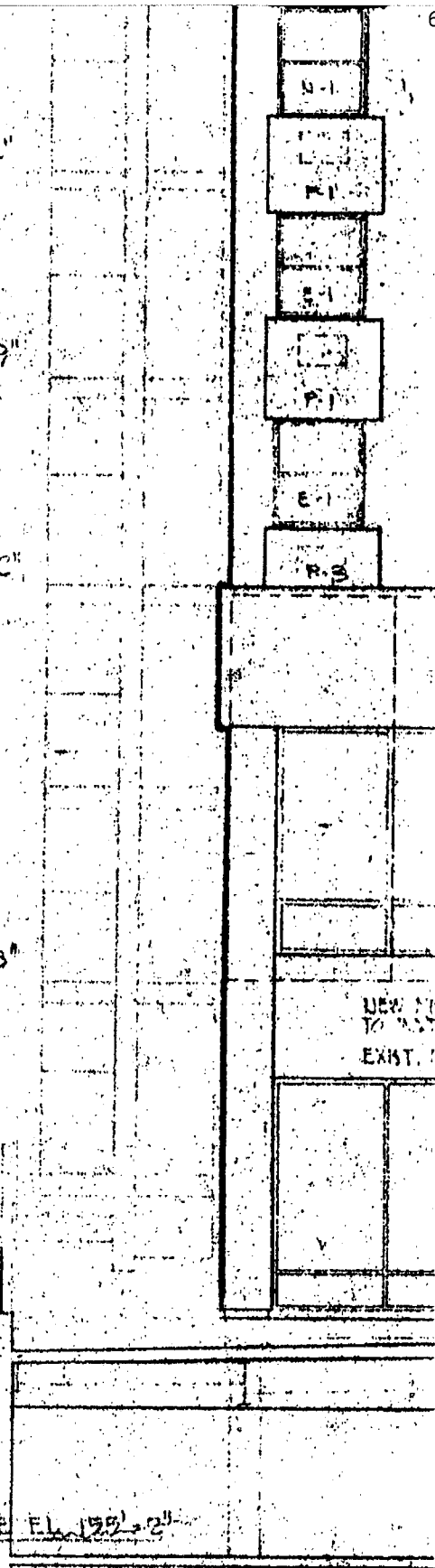
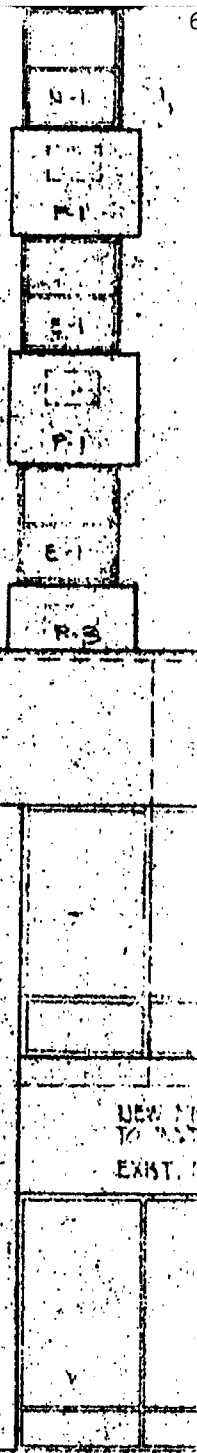

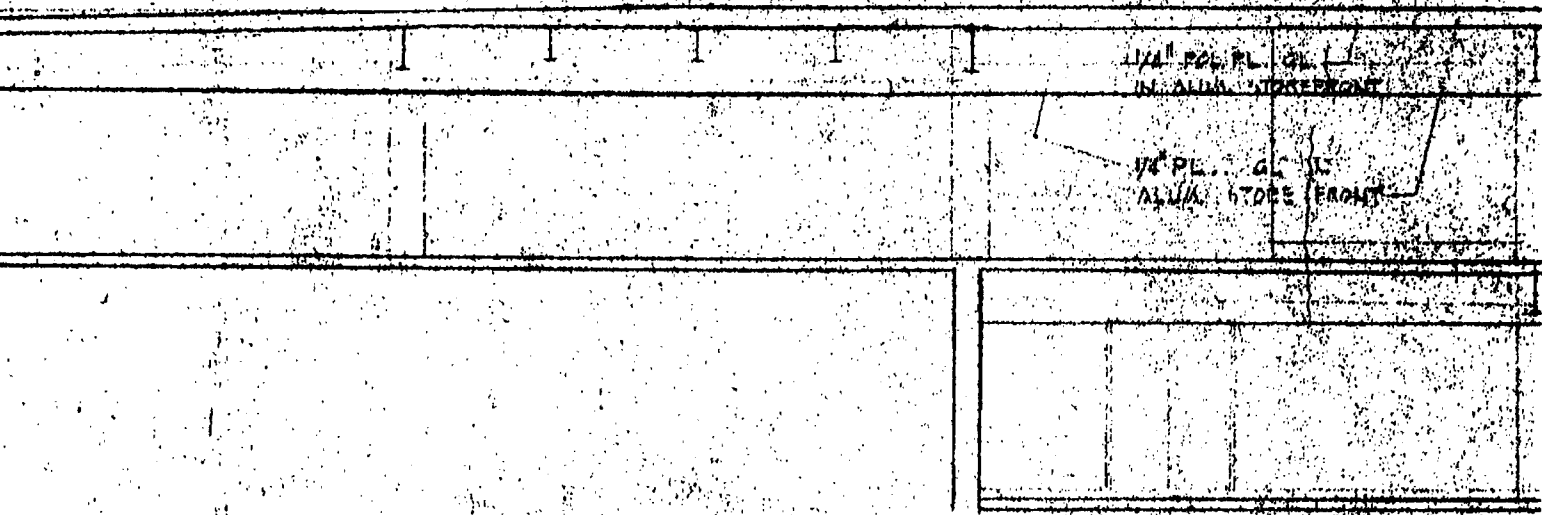
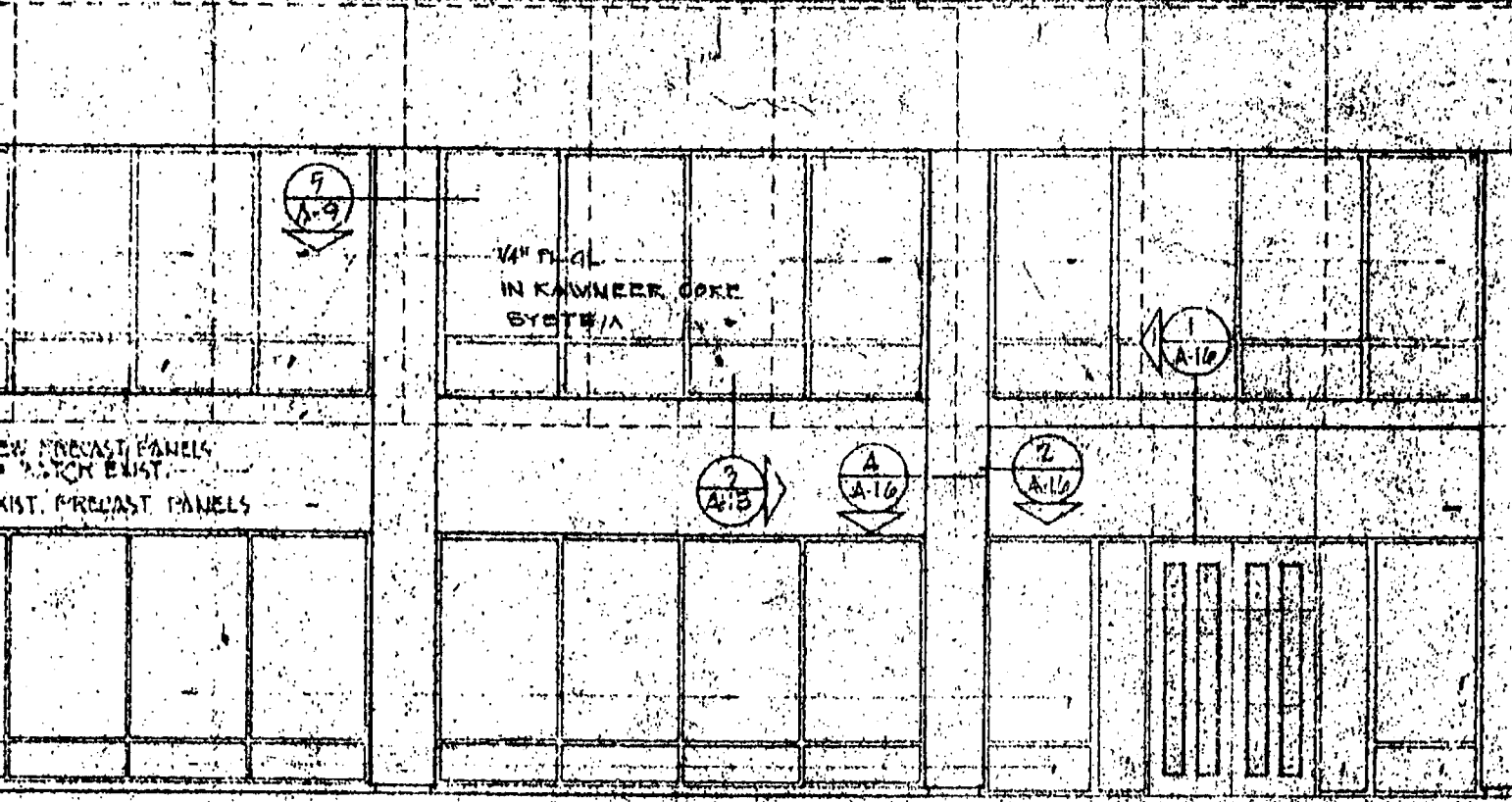
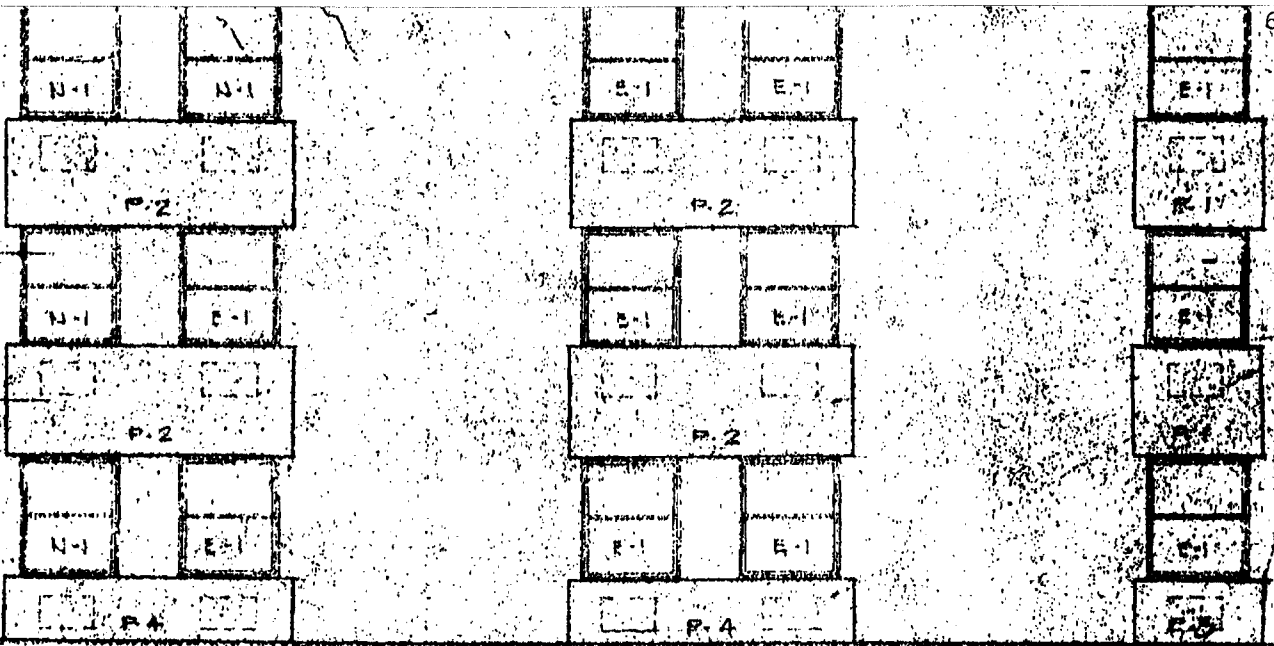

EXIST. PRECAST
PANELS TO REMAIN
CAULK JOINTS
WEATHER-TIGHT
SEE SET



EXIST. WINDOWS

NEW PRECAST PANELS
SEE SET



REMOVE EXIST. PRECAST
SHOWN DOTTED

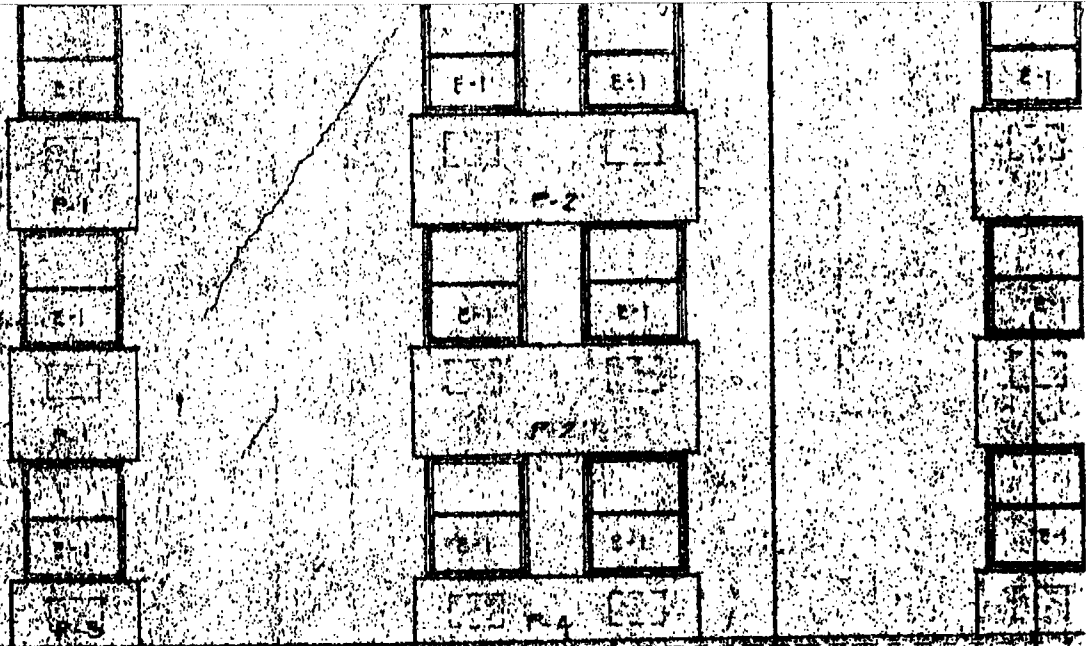

WHITE PC PAINT CONTROL JOINTS AS SHOWN



CANDY

CER. TILE



EXIST. PRECAST PANELS

4" FL. AL.
IN KAWNEER
CORE SYSTEM



4" FL. AL.
IN KAWNEER
CORE SYSTEM



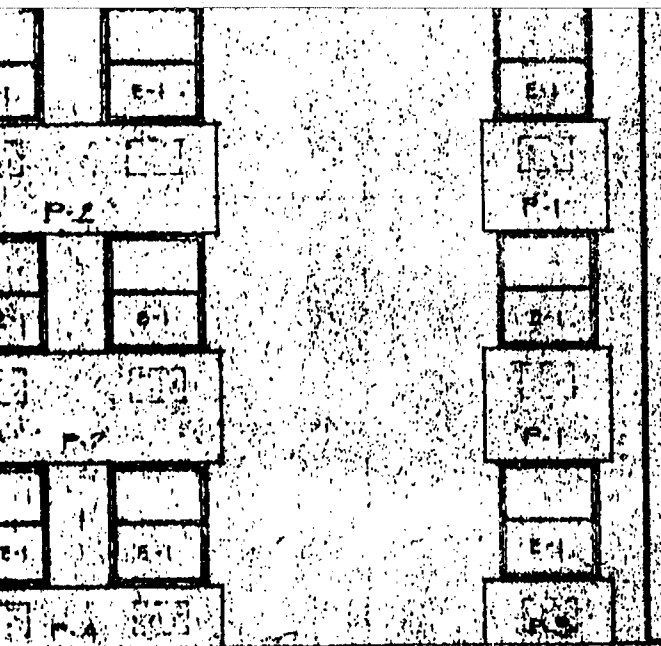

TYPICAL PANEL CONNECTION D

- PANEL NOTES FOR PANELS P-1 THRU P-4
1. BACK FACE OF PANELS ARE SHOWN
 2. ALL 4 SIDES OF LULU TO BE SET IN GROUT
 3. FRONT FACE & EDGES OF PANELS TO BE #4 TO #5 AGGREGATE (APPROVED SAMPLE)
 4. SEE PANEL SECTIONS ON DET. 5
A-14

1 PRECAST PANEL DE
(FOR PANELS P-1 THRU P-4)

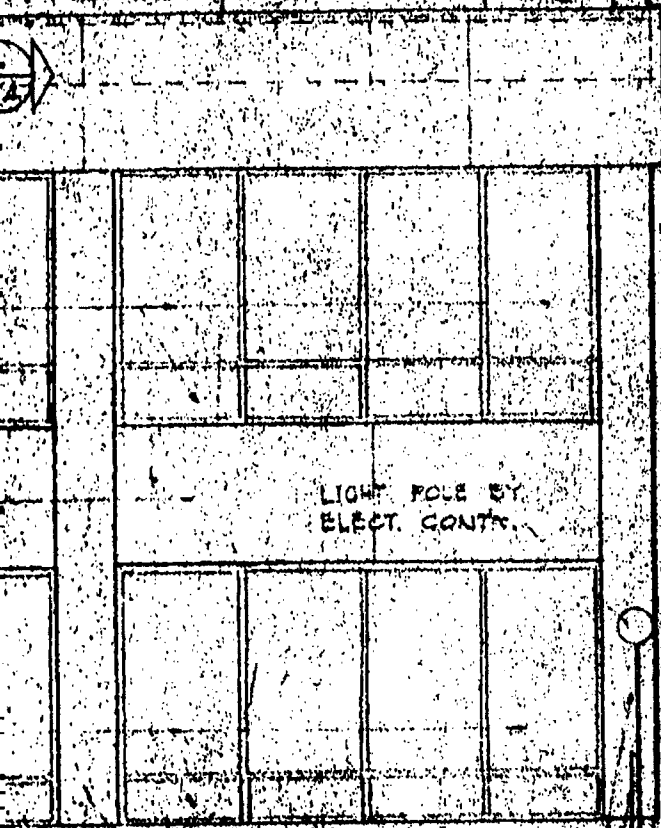

WHITE PLASTER ON ALL
INT. SURF. EX. EX. CORN.

SEE RAILING DET. 5
A-5

RAILING SEE DET. 1
A-5

WINDOW DESCRIPTION
SEE NOTE ON SH. A-4

4" x 1/4" x 1'-0" BELT PL.

Ø OF 1/2" ANCHOR BOLT

EXIST. PRECAST PANEL

CAL. PANEL CONNECTION DET. SC: 1/2" x 1'-0"

NOTES FOR PANELS P-1 THRU P-4
BACK FACE OF PANELS ARE SHOWN
ALL SIDES OF LUGS TO BE SET IN GROUT
OUT FACE & EDGES OF PANELS TO BE
TO #2 AGGREGATE / APPROVED SAMPLE
PANEL SECTIONS ON DET.



PRECAST PANEL DETAILS
(FOR PANELS P-1 THRU P-4)

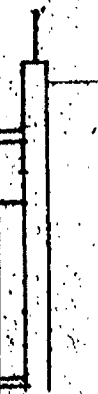

HOUSE NEBRASKA
NIGAS GOLDSTEIN &
INC. M.A.H.

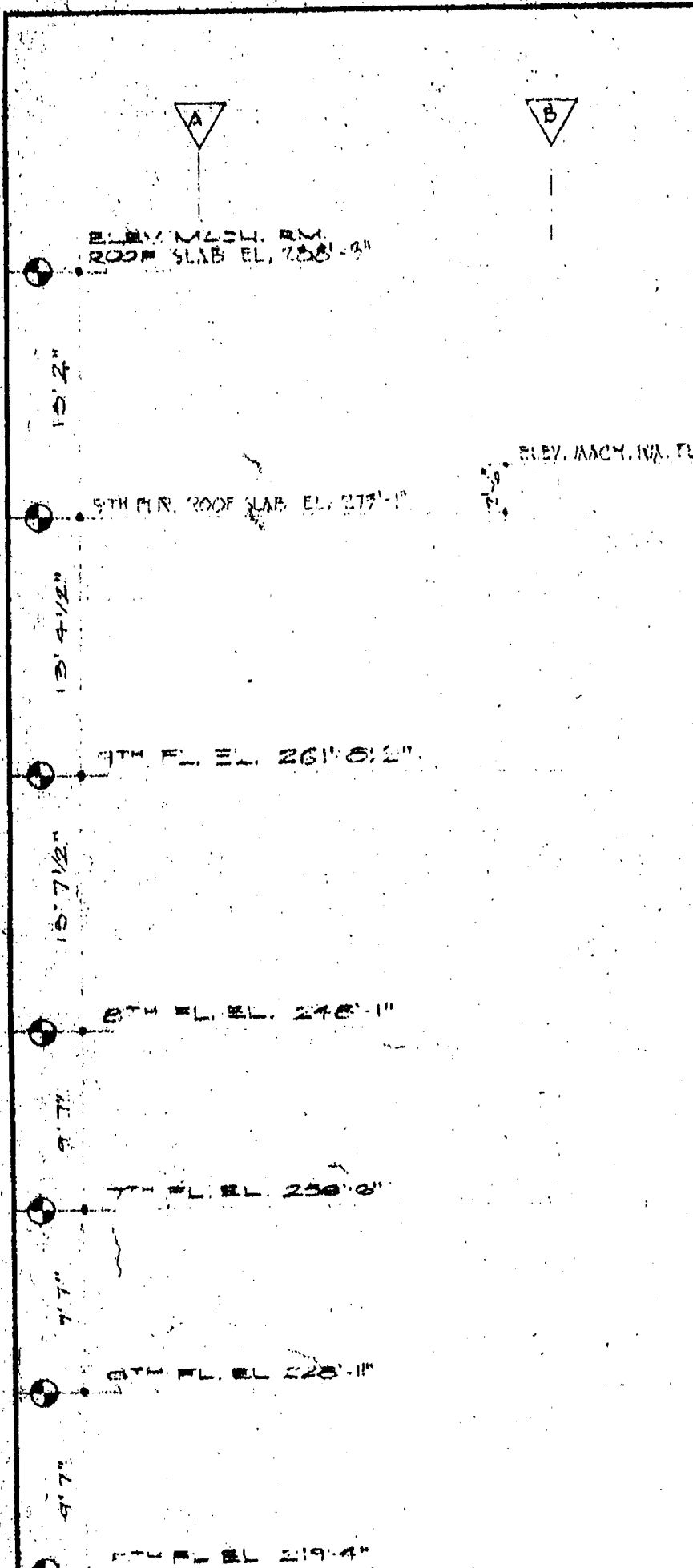

ELEV. MACH. RM.
ROOF SLAB EL. 258'-3"

15'-2"

5TH FL. ROOF SLAB EL. 275'-1"

13'-4 1/2"

4TH FL. EL. 261'-8 1/2"

15'-7 1/2"

5TH FL. EL. 248'-11"

9'-7"

7TH FL. EL. 256'-6"

7'-7"

6TH FL. EL. 228'-11"

9'-7"

8TH FL. EL. 219'-4"

ELEV. MACH. RM. FL.

B

C

D

BREV. MACH. IVA. FLIR. EL. 277-7^A

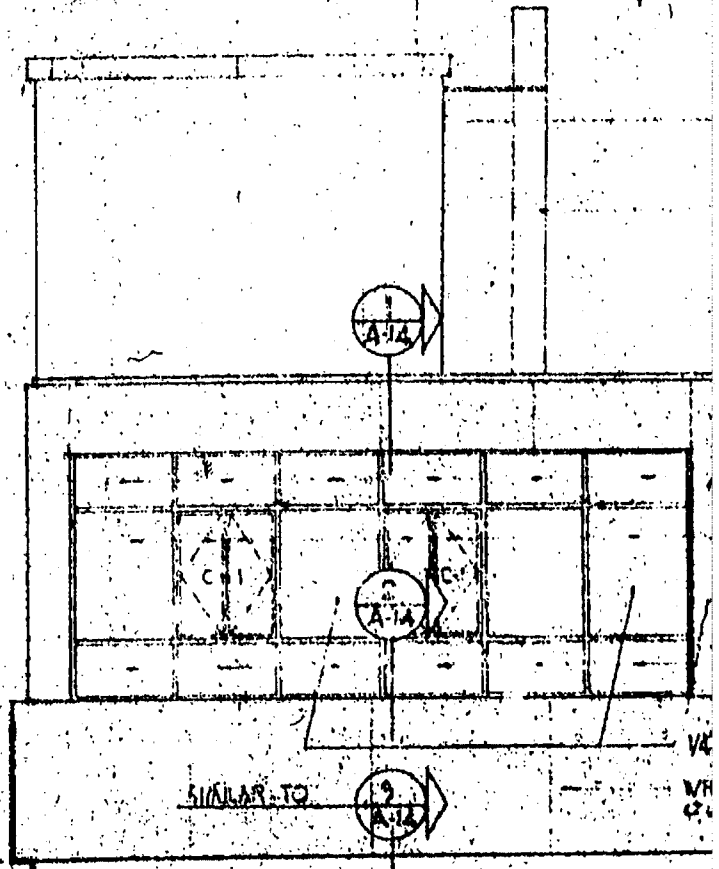

SIMILAR TO

2
A-14

VA
VF
C

E

F

H

J

SEE SH. #A-20 FOR ELEV.
MACH. TRK. DETAILS

FLUR BY MECH. CONTR.

WHITE P.C. PLAST. ALL 9" H
FLY. COILS & FASCIA. WITH
EXP. JOINTS AS SHOWN

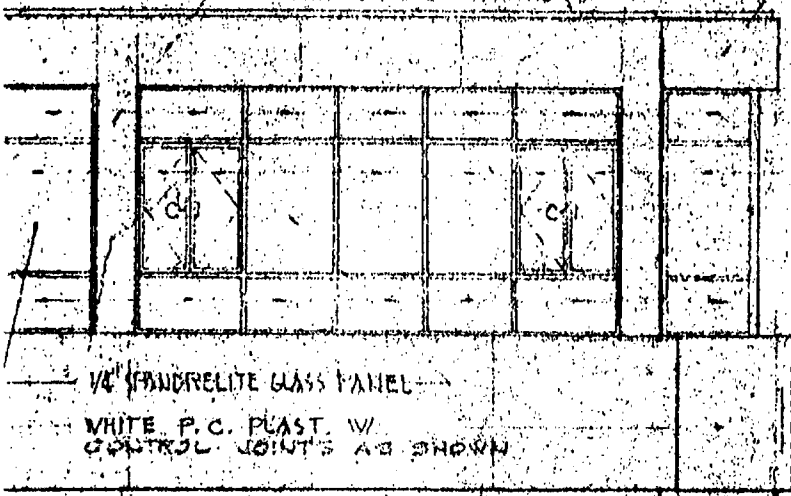

7/8" SOLAR GREY
INSUL. GLASS
1/4" GLASSWELD PANELS

1/4" FIBERGLITE GLASS PANEL
WHITE P.C. PLAST. W.
CONTROL JOINTS AS SHOWN

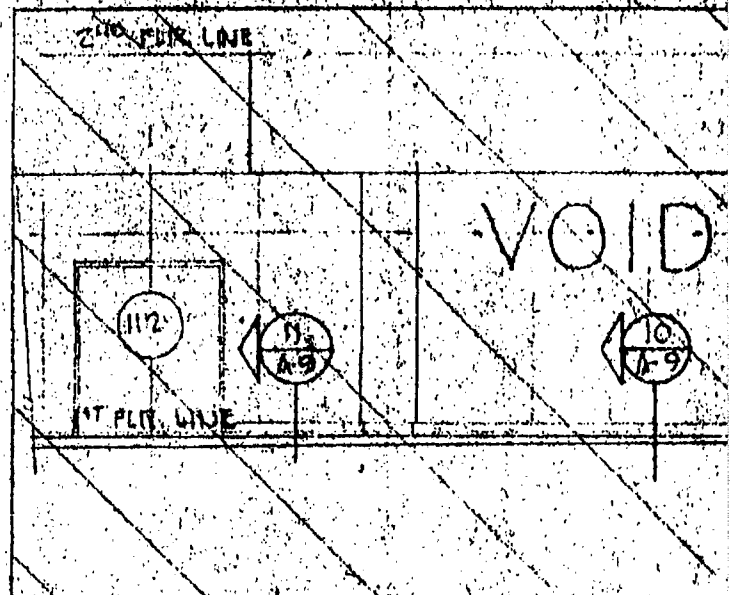

K

K

J

H

WHITE P.C. PLASTER

1/4" SPANDRELITE
GLASS PANEL

1/2" GLASSVELD PANELS

3/8" SOLAR WRDY
INSUL. GLASS

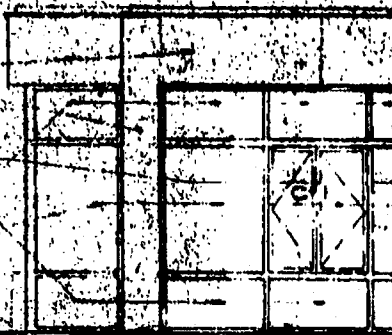

12
A-9

WHITE P.C. PLASTER
WITH REINFORCING
MOUNTS AS SHOWN

3
A-9

CONC. CURB

PAVING LINE

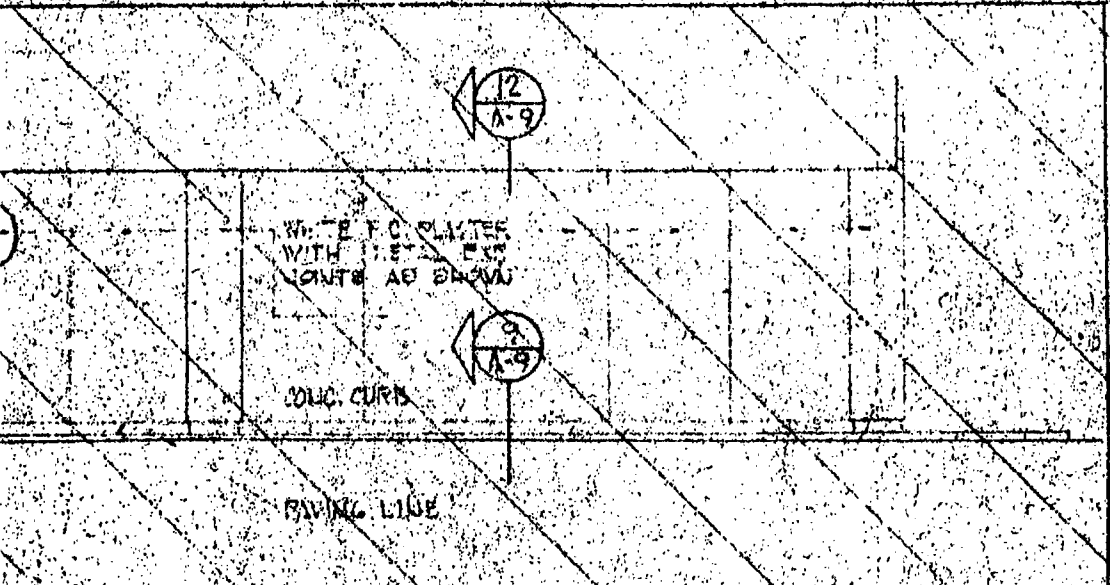

F E D C

BLUE BY ARCH. CONTR.

SEE SH. 2-20 FOR ELEV. ARCH. DETAILS

SIMILAR TO 1 A-14

ELEVATOR MACH. RM. FOR E. 17'-0"

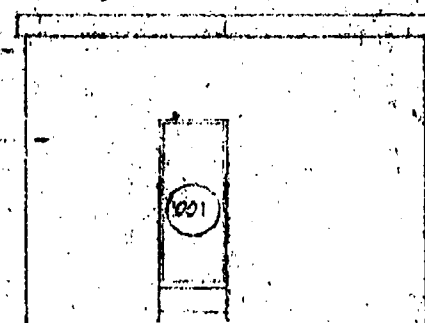

ELEV. MACH. RM. 9TH FL. EL. 285'-0"

9TH FL. ROOM 9TH FL. EL. 279'-0"

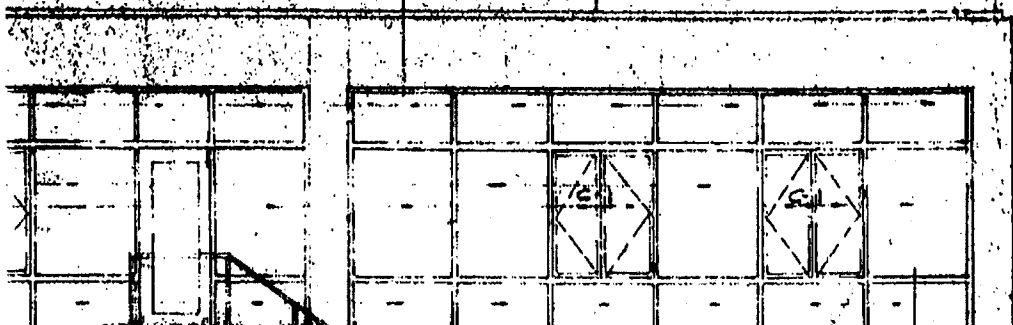

SIMILAR TO 2 A-14

WHITE P.C. PLAST

STOP WHITE P.C. PLAST BAND EACH SIDE SIM. OF EXIST' ST. STAIR 5 A-14

9TH FL. COR. 9TH FL. EL. 279'-0"

8TH FL. EL. 270'-0"

7TH FL. EL. 260'-0"

6TH FL. EL. 250'-0"

EXIST. ST. STAIR TO REMAIN. REPAIR, COMPLETE & PAINT.

EXIST. FINISH TO REMAIN

date	revision
10-25-66	2-B-67
Job no	5-22-67
6819	5-2-67

ASSOCIATES, inc - architects
 N E B R A S K A

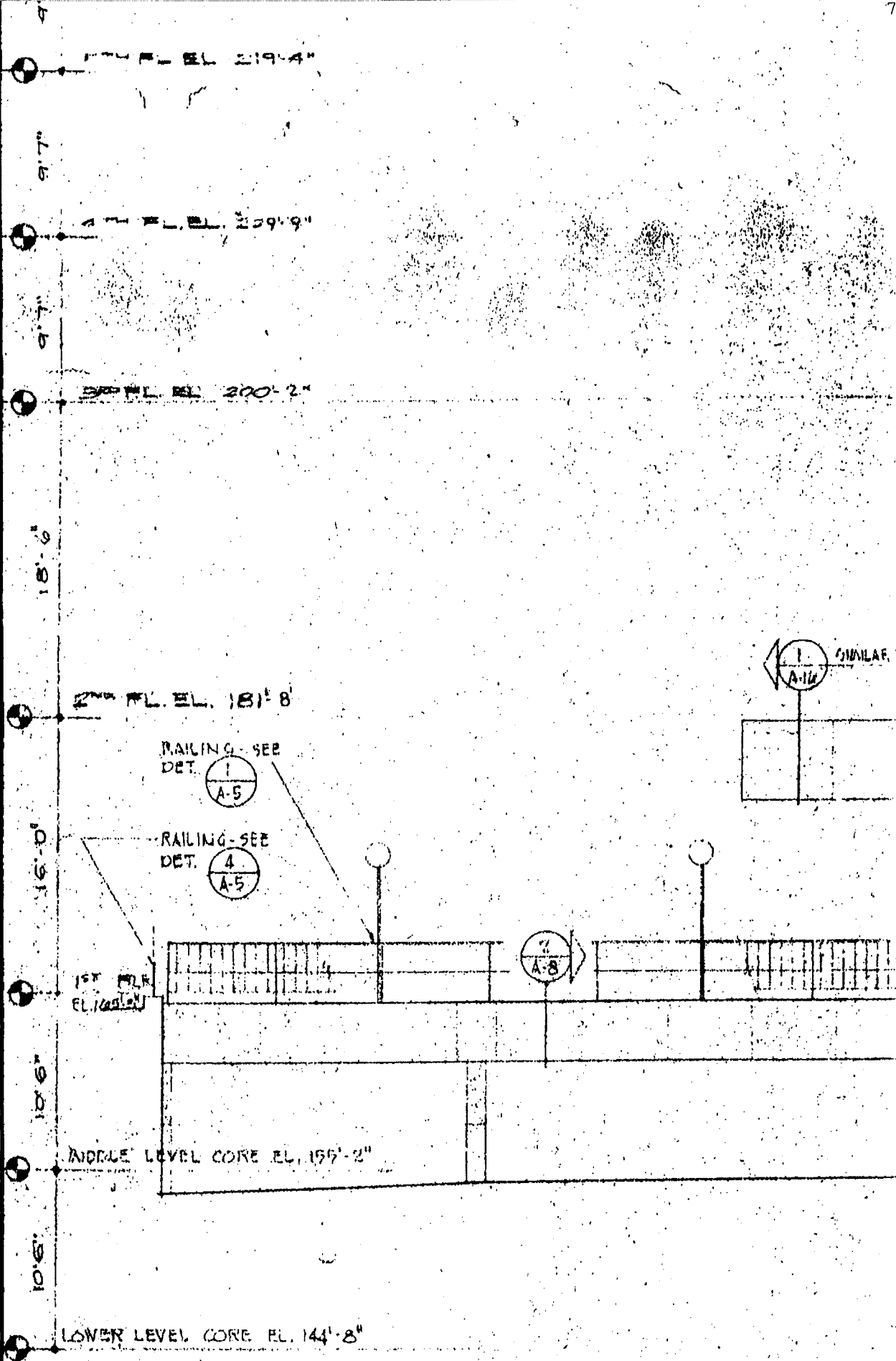

EXIST. PRECAST
TO REMAIN
CALL OUTS
WEATHER TIGHT
SEE DET. 

SIMILAR TO 

REMOVE EXIST. PRECAST
(SHOW) DOTTED

B
A-14

WHITE P.C. PLAST. W/
CONTROL JOINTS AS SHOWN

C
A-14

1/4" PL. G.I.
IN KAWNEER CORE SYSTEM

LAR TO

EXIST. PRECAST

D
A-8

1/4" PL. G.I.
IN KAWNEER CORE SYSTEM
WHITE P.C. PLASTER

REMOVE EXIST. RAILING

1ST FLOOR NORTH WALL ELEVATION

16' 0" x 10' 0"

ALUM. CAP FLASHING

WHITE
ACE-150
COY OF

SIMILAR 

SIMILAR 

W. PL.
N. 100%

NEW PRECAST PANELS
TO MATCH EXIST.

NOTE: FOR ALL RAILINGS
SEE DET. 
UNLESS OTHERWISE
NOTED.

NEW WIRE
TO MATCH

CONCRETE SPANDREL
1/2" TO 1/4" BROWN

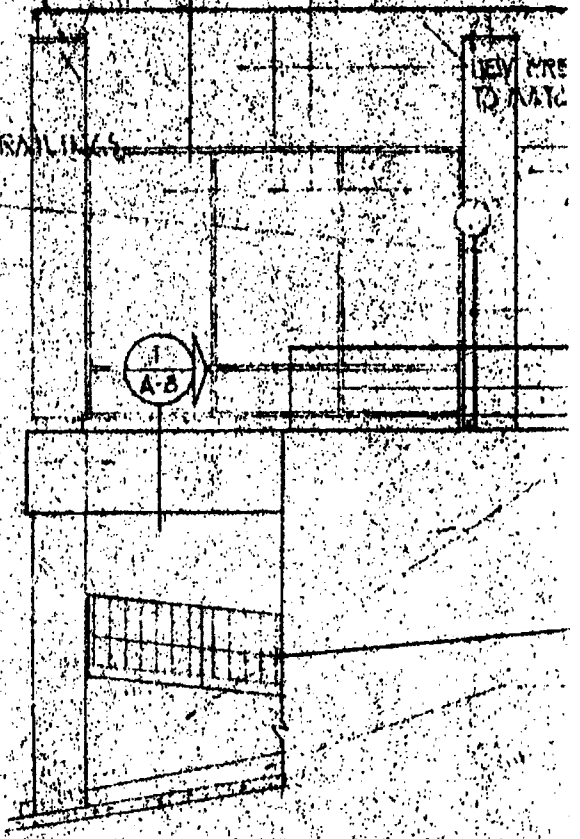
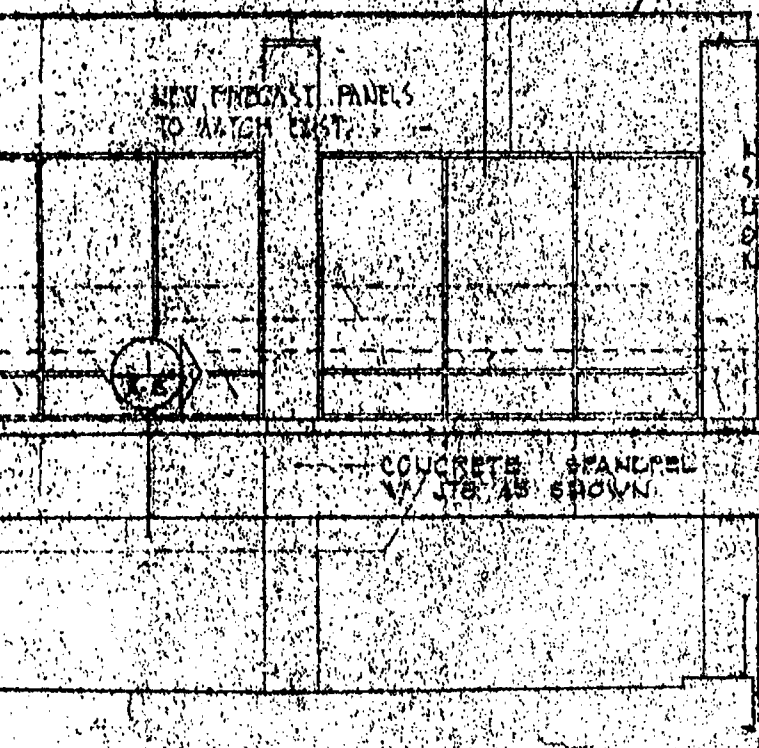

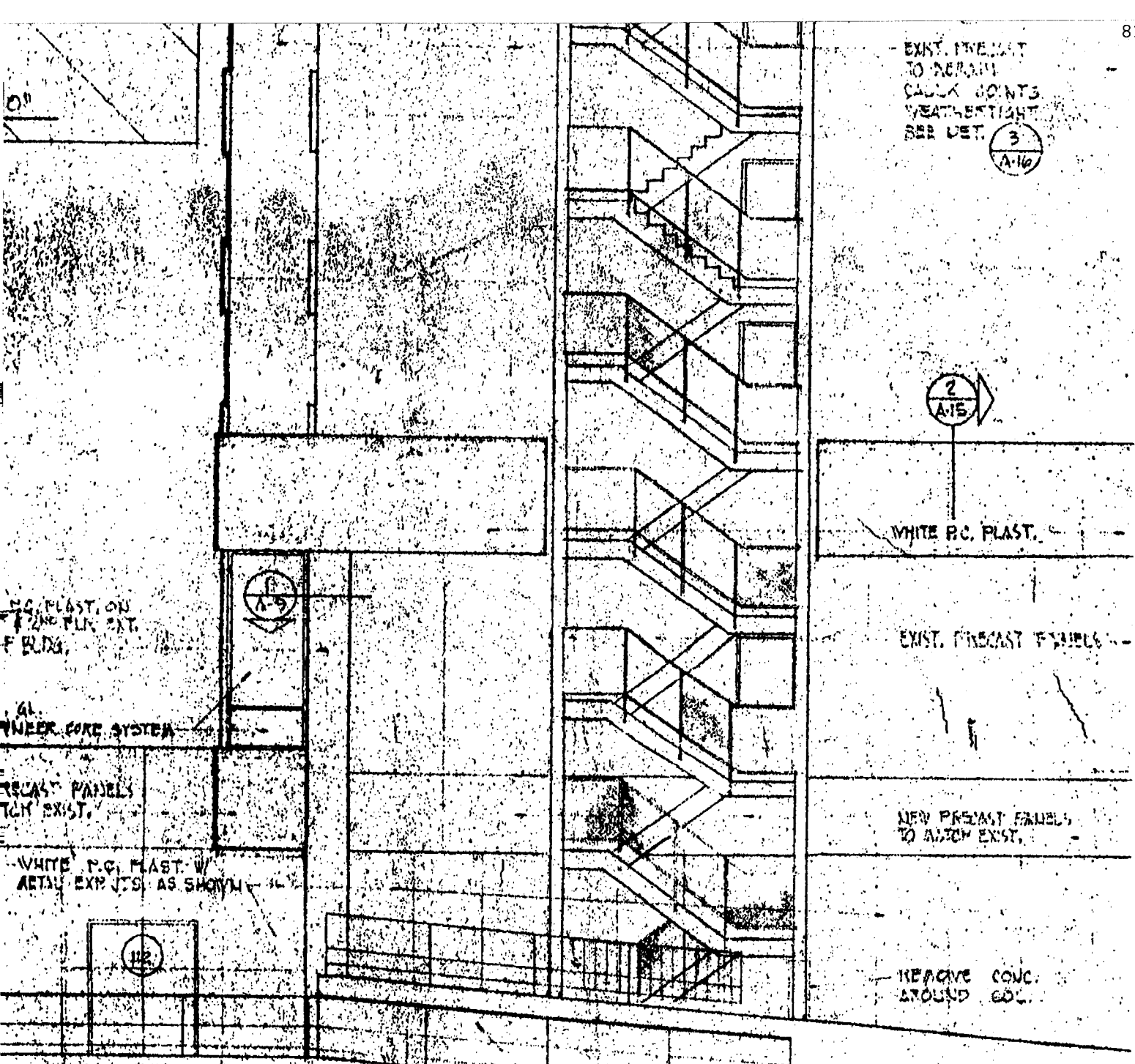

- EXIST. PRECAST
TO REMAIN
CHECK JOINTS
WEATHERTIGHT
SEE DET. 3

2
A15

WHITE P.C. PLAST.

EXIST. PRECAST PANELS

NEW PRECAST PANELS
TO MATCH EXIST.

REMOVE CONC.
AROUND G.O.

P.C. PLAST. ON
1/2" AND 1/4" EXT.
F. BLDG.

AL.
TYPICAL CORE SYSTEM

PRECAST PANELS
TO MATCH EXIST.

WHITE P.C. PLAST. W/
ACTUAL EXP. JTS. AS SHOWN

112

SIMILAR TO EAST SIDE WALL USED
FOUR COATS TO MATCH EXIST. WALL
GRADE LINE

8" REINF. CONC. WALL

EXIST. EXTER. WALL TROWEL ON NEAT CEMENT COAT

EXIST. CONC. WALL, FILL RECESSES, GRIND
OFF ROUGH SPOTS & TROWEL ON NEAT
CEMENT COAT TO MAKE SMOOTH, STRAIGHT
& TRUE, ON EXPOSED EXTERIOR TOP &
NORTH & SOUTH SURFACES.

EXIST. PRECAST
TO REMOVE
CALL JOINTS
WEATHERTIGHT
SEE DET.



5TH FLR. EL. 219

4TH FLR. EL. 209

3RD FLR. EL. 200



WHITE PC. PLAST.

EXIST. PRECAST PANELS

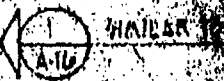

WALLER 12"

2ND FLR. EL. 191

NEW PRECAST PANELS
TO MATCH EXIST.

REMOVE CONC.
AROUND COL.

1ST FLR. EL. 182

WALL, FILL RECESSES, GRIND
SPOTS & TROWEL ON NEAT
TO MAKE SMOOTH, STRAIGHT
EXPOSED EXTERIOR TOP &
VERT SURFACES.

11. LEVEL CONC.
EL. 175

1. LEVEL CONC.
EL. 14' 3"

NIGAS - GOLDSTEIN &
O M A H A

INGA

HOUSE
NEBRASKA

SE



5/8" SOLID GREY
INSUL. GLASS

12

11

10

1
A-5

1
A-14

1/4" G

7/8" SOLAR GREY
INSUL. GLASS

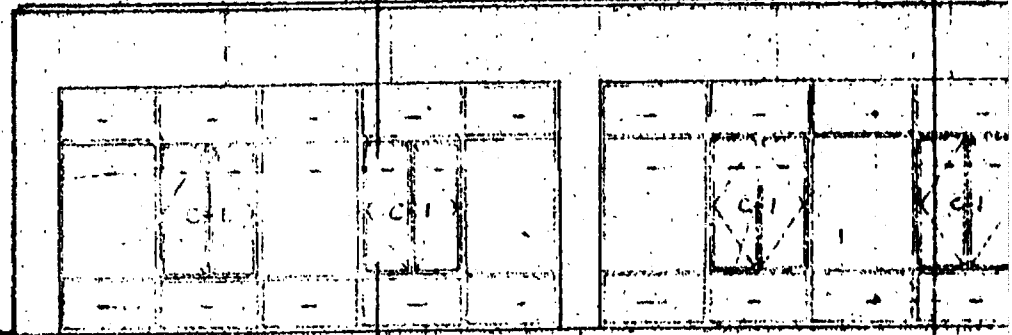

2
A-14

3
A-14

1/4" SPACER
GLASS PANEL

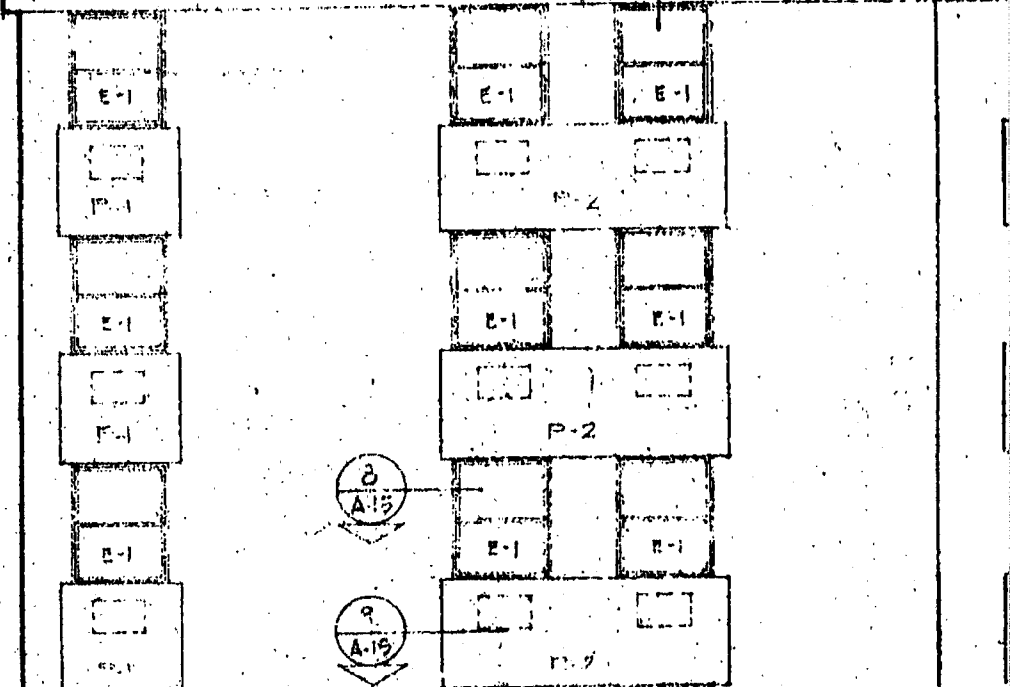

8
A-15

9
A-19



SEE SHE ELEVATE DETAILS

1/4" GLASS WELD PANELS

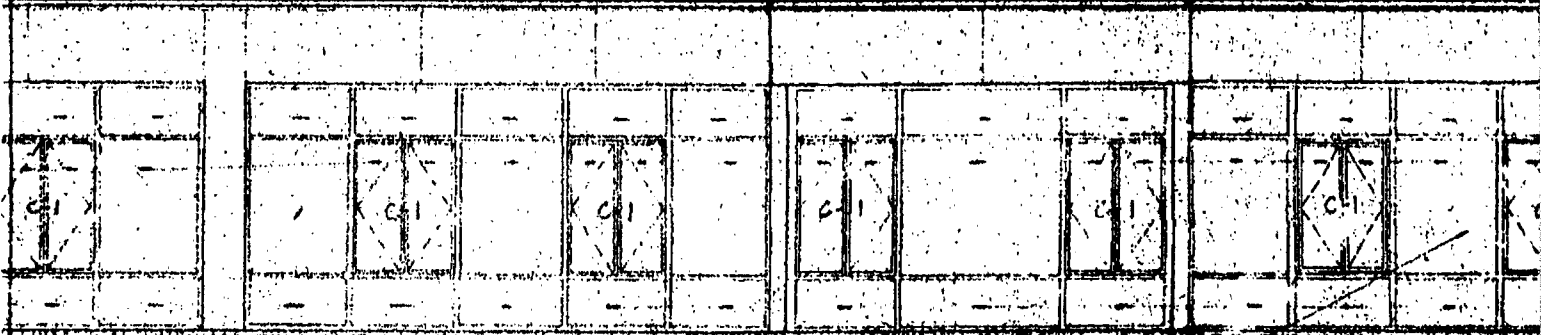

URELITE PANELS

WHITE P.C. PLMT. W CONTROL

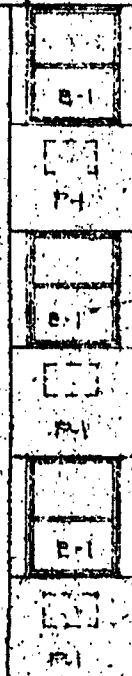
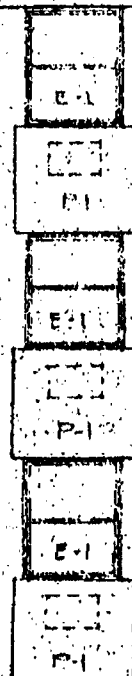
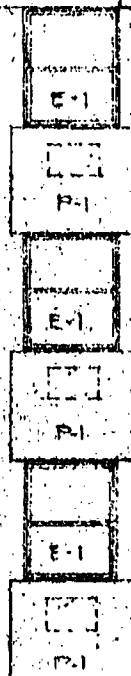
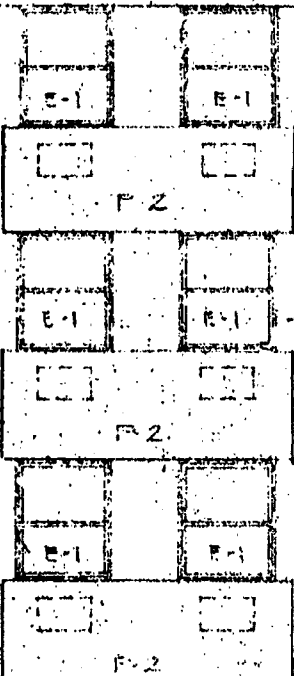

EXIST. WINDOW

EXIST. PREG PANELS TO REMAIN, CAUTION WEATHERING SEE SHEET

4

3

2

DEPT A-20 FOR
TOR MACH. ROOM
S

WHITE P.C. PLASTER
ALL 9TH FLR. FASCIA &
COLUMNS WITH EXP
JOINTS AS SHOWN

ELEV. MACH. RM. FLR.
EL. 277'-7"

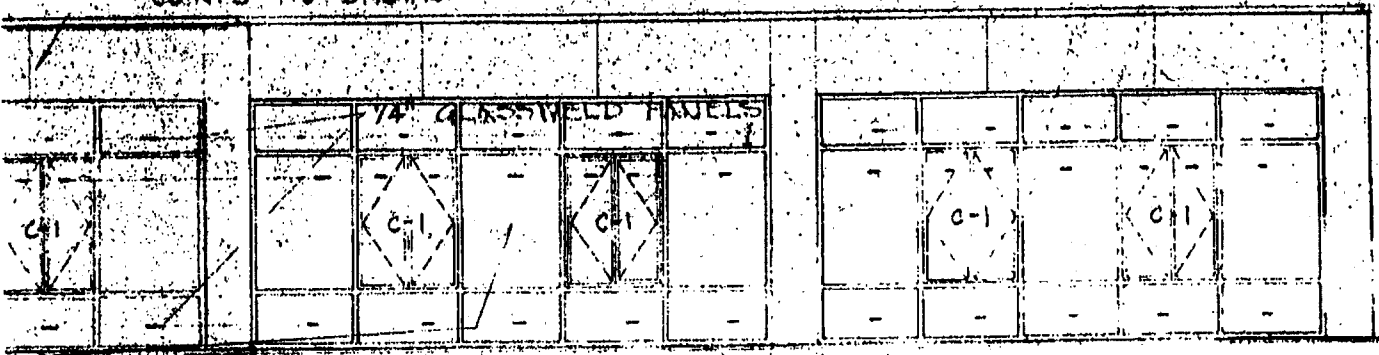

JOINTS AS SHOWN

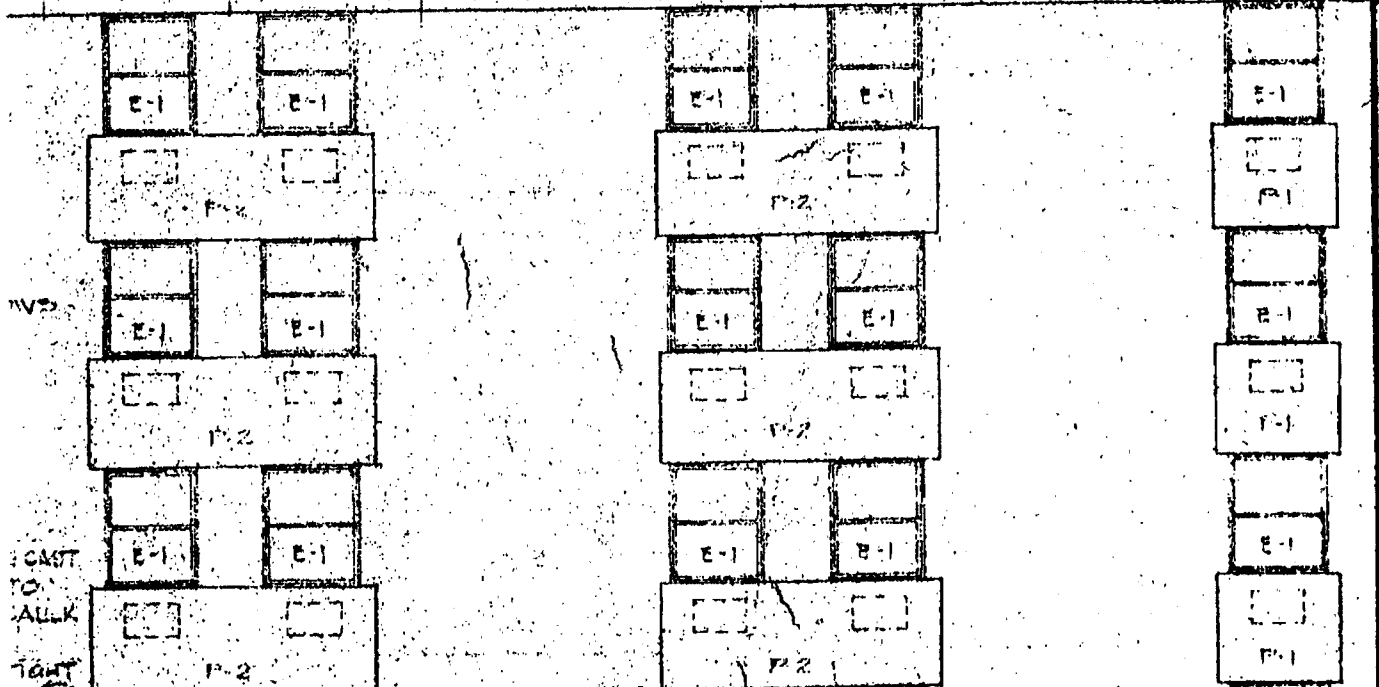

WVS

CAST

WALK

JOINT



ELEVATOR MACH RM ROOF SLAB
ELEV. 266'-5"

13'-2"

9TH FLR. ROOF SLAB
ELEV. 275'-1"

13'-4 1/2"

4TH FLOOR
ELEV. 281'-6 1/2"

13'-7 1/2"

5TH FLOOR
ELEV. 290'-1"

9'-7"

7TH FLOOR
ELEV. 296'-6"

9'-7"

6TH FLOOR
ELEV. 228'-11"

revision
1
2

date
7-5-67
7-22-67

date
10-25-66
JOB NO
6519

& ASSOCIATES, inc · architects
N E B R A S K A



ALUM. CAP FLASHING

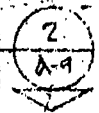

FOR ALL RAILINGS ON
 1ST FLR, MIDDLE PARKING
 LEVEL, & LOWER PARKING
 LEVEL, SEE DET. 
 UNLESS OTHERWISE
 NOTED

FOR RAILING
 SEE DET. 

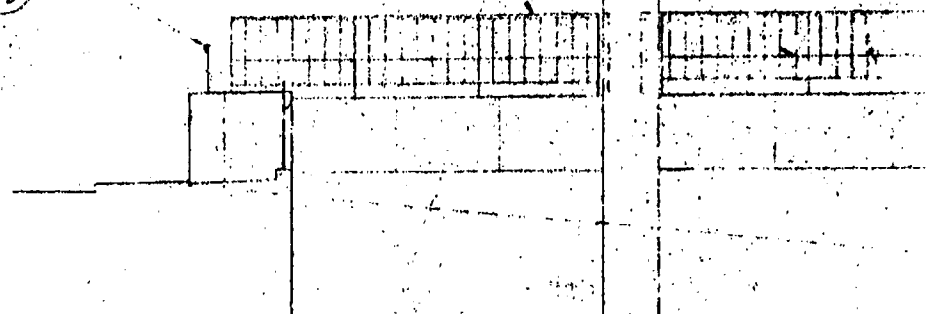

A-15

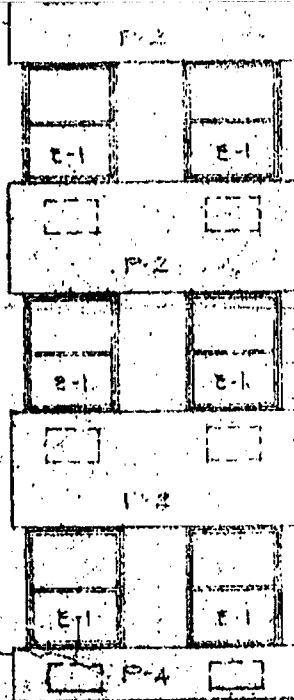
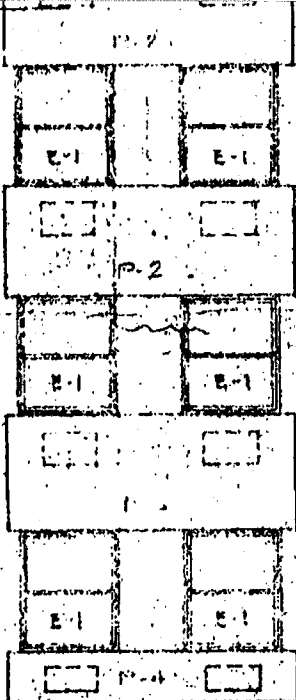

WHITE P.C. PLAST. W CONTROL JOINTS AS SHOWN

3
A-19

4
A-9

17
A-19

VA
P
CC

7/8" PL. 60
6 IN. KAMBER CORE SYSTEM

REMOVE EXIST. RAILING

WHITE

1
A-9

CONC
VI 3

1
A-7

CONC
VI

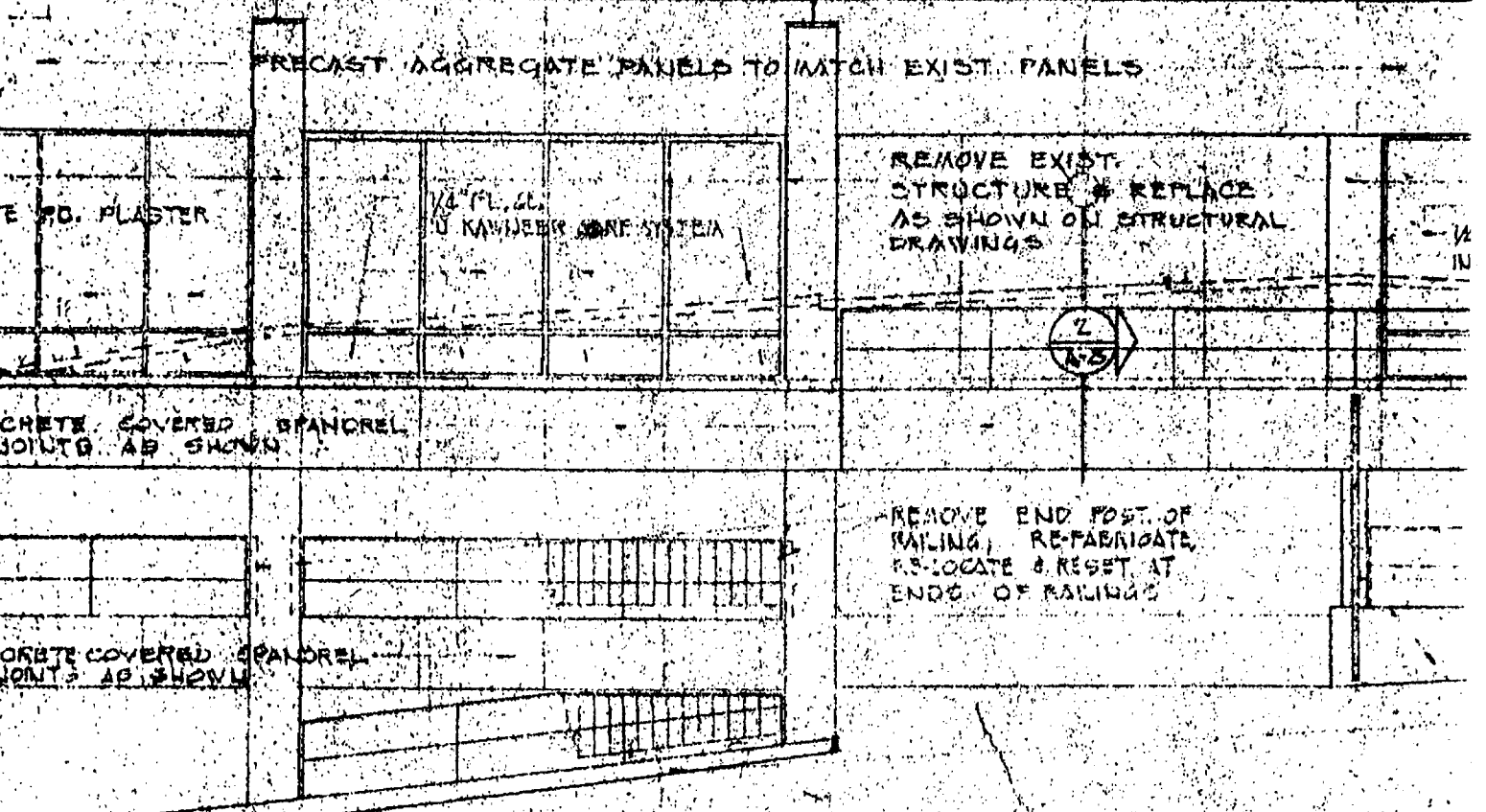
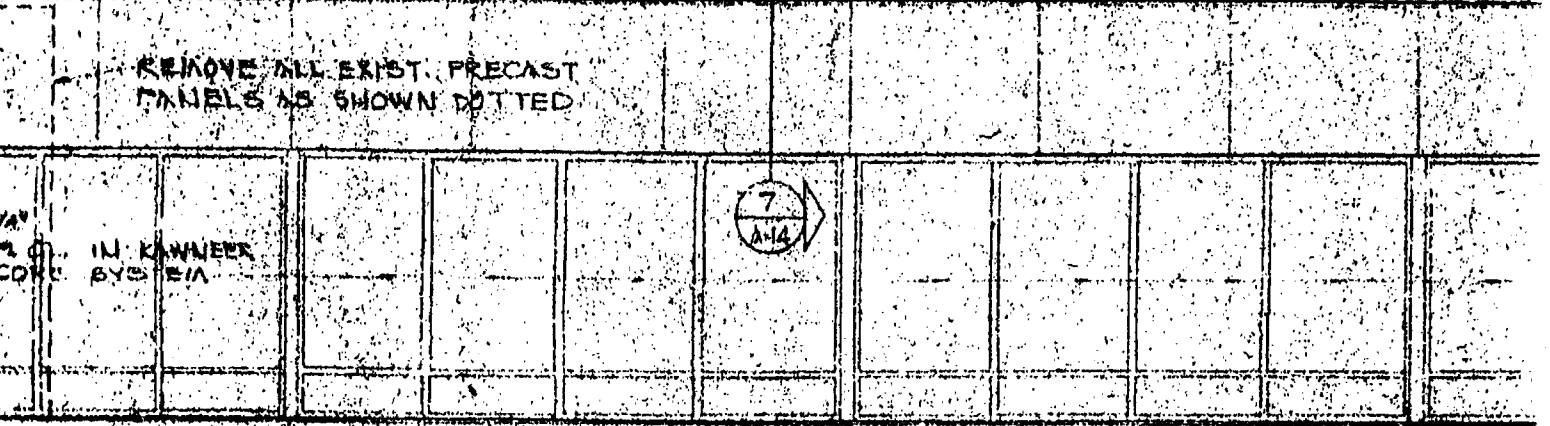
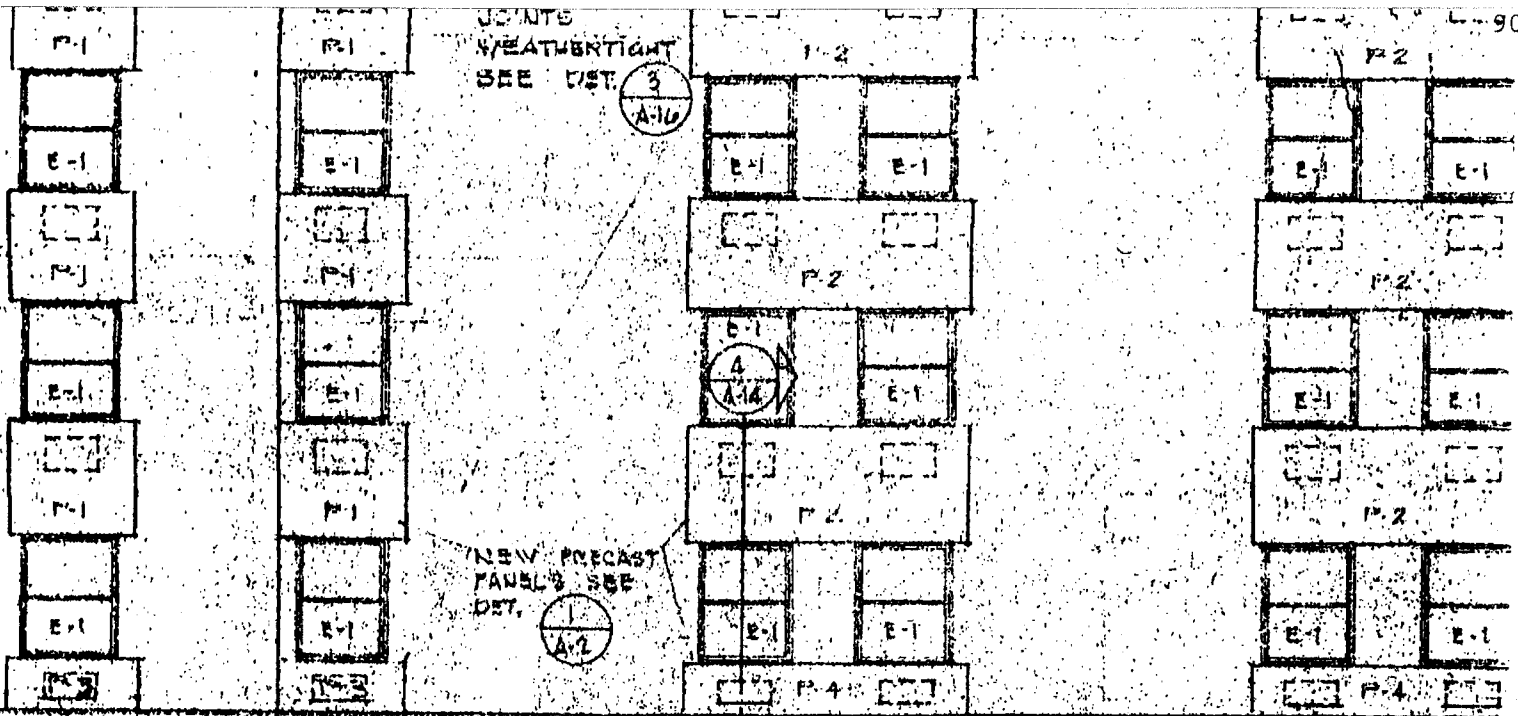

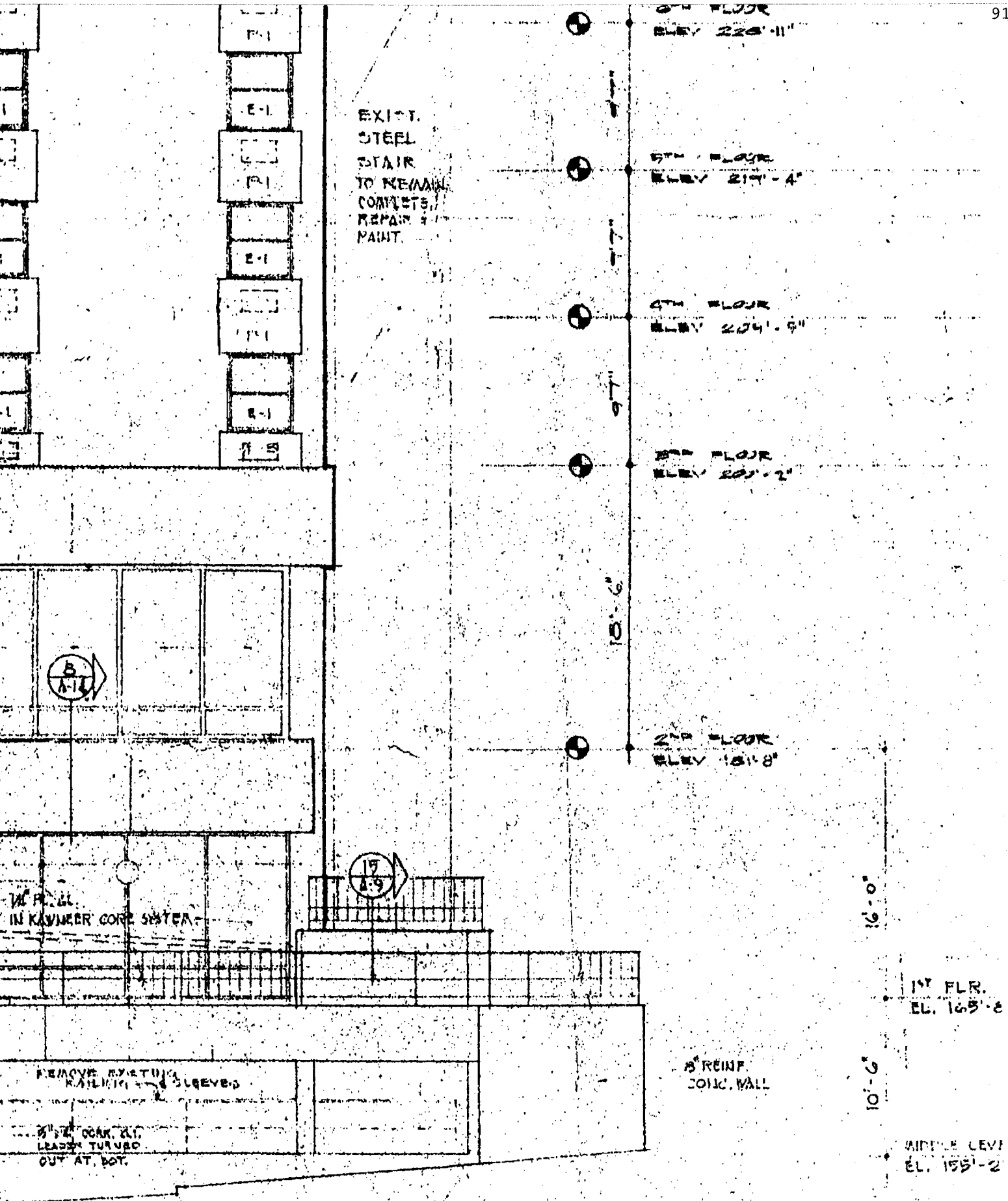

EXIST.
STEEL
STAIR
TO REMAIN
COMPLETS.
REPAIR &
PAINT.

6TH FLOOR
ELEV 228'-11"

5TH FLOOR
ELEV 219'-4"

4TH FLOOR
ELEV 209'-9"

3RD FLOOR
ELEV 201'-2"

2ND FLOOR
ELEV 181'-8"

1ST FLR.
EL. 165'-8"

MIDDLE LEVEL
EL. 155'-2"

18'-6"

16'-0"

10'-6"

10'-6"

5" REINF.
CONC. WALL

REMOVE EXISTING
RAILING & SLEEVES

3/4" OAK, EL.
LEADS TURNED
OUT AT BOT.

GRIND TOP SMOOTH & LEVEL,
FILL RAILING GREEVE LOCATIONS AS NEC.
W/ CONC. & TROWEL ON NEAT CEMENT
PLASTER COAT ON EXPOSED EXTENSION TOP EAST & END SURFACES

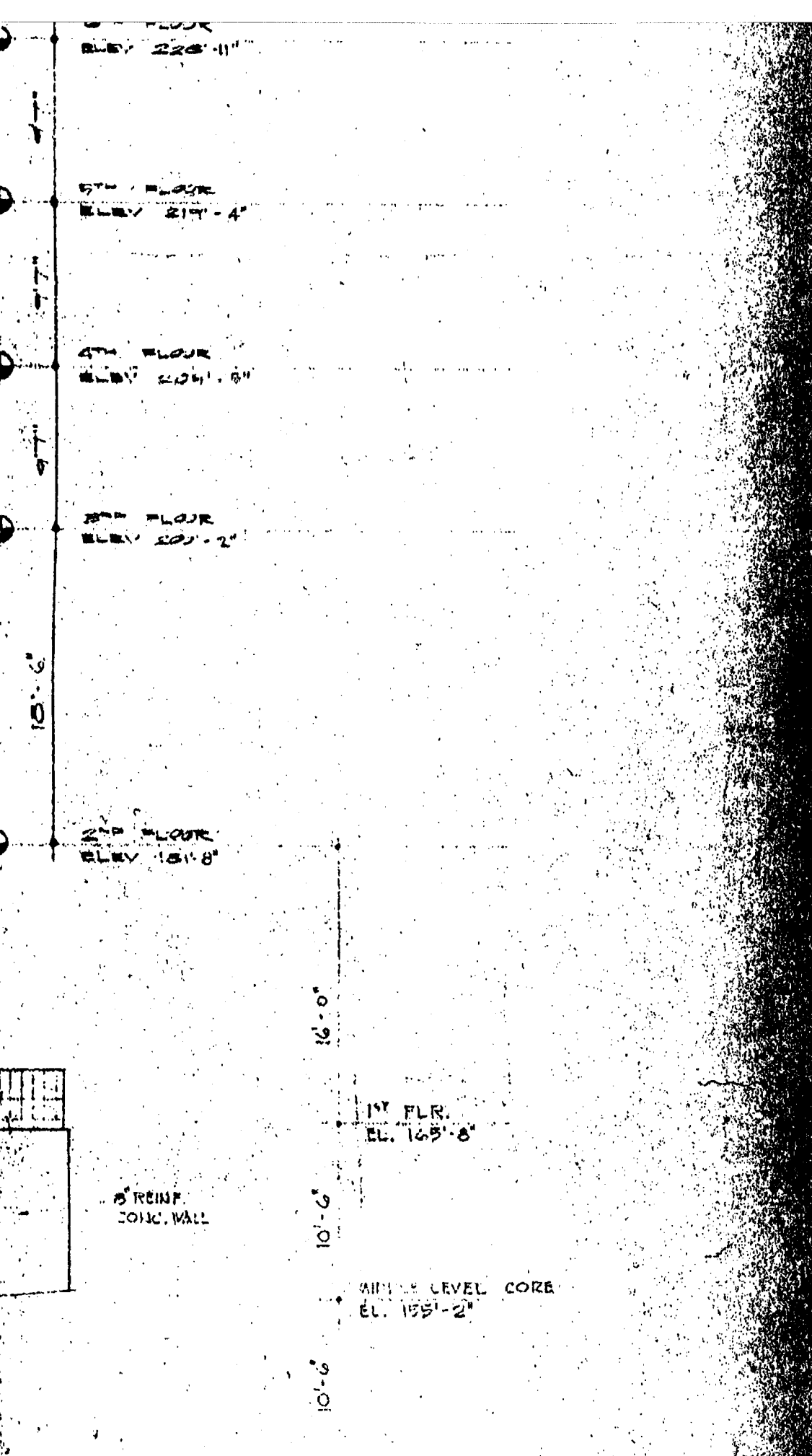

NIGAS · GOLDSTEIN &
 O · M · A · H · A

WIGA

GE HOUSE
 NEBRASKA

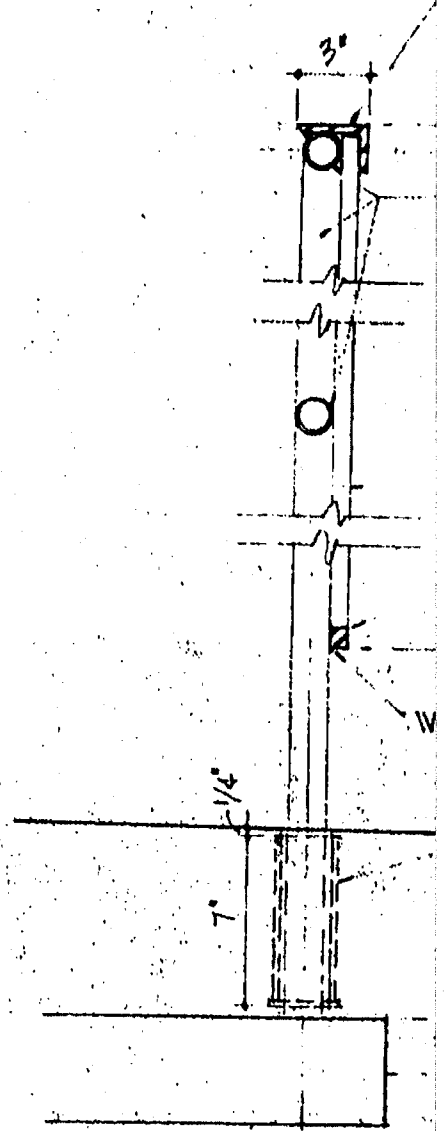

1 RAILING SECTION

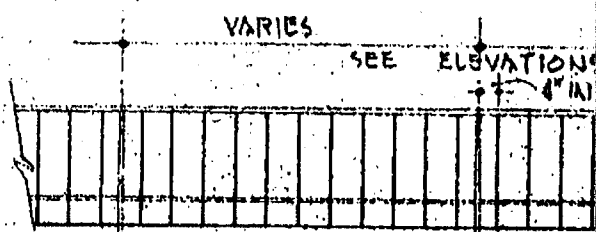

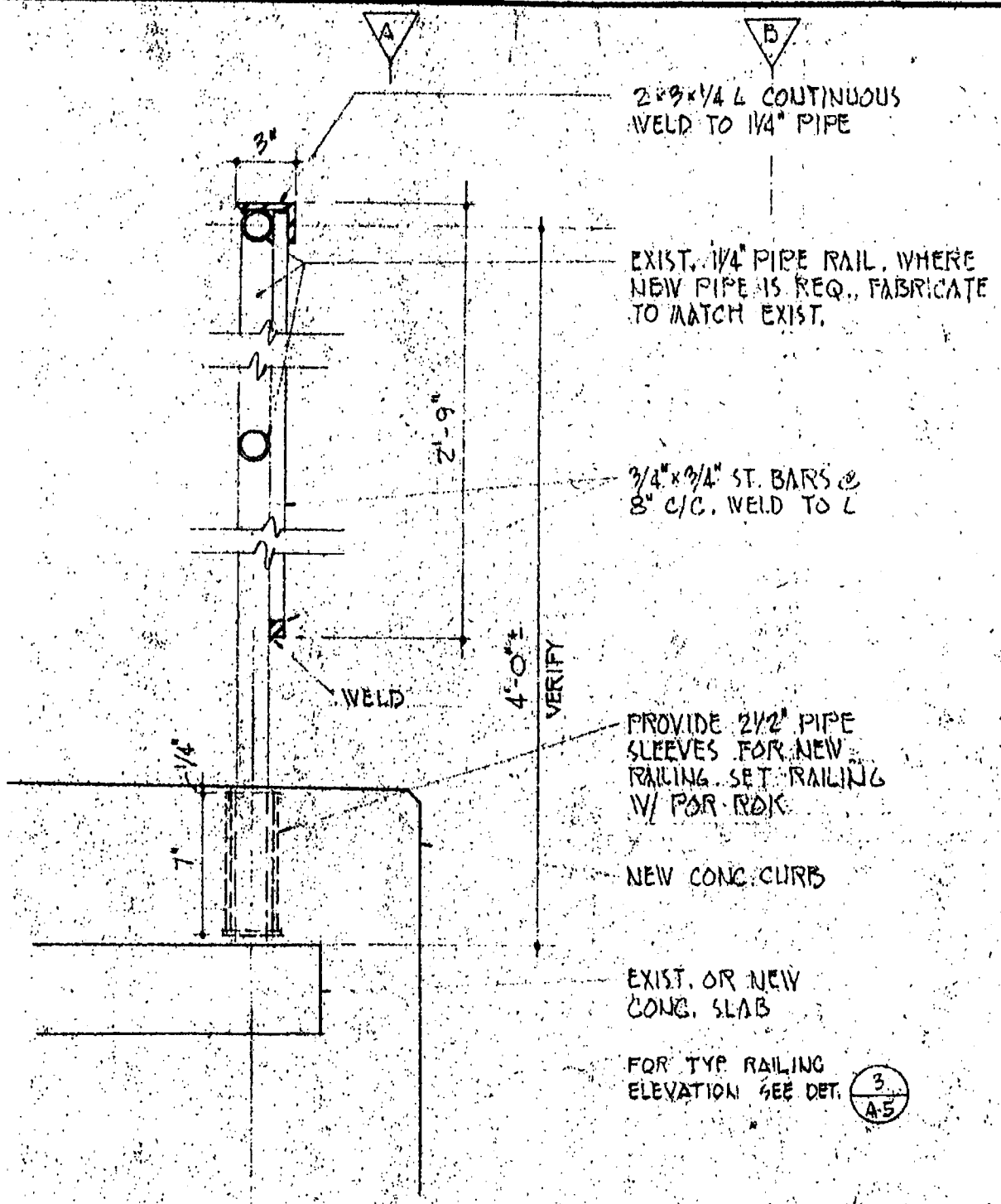

2x9x1/4 L CONTINUOUS
WELD TO 1/4" PIPE

EXIST. 1/4" PIPE RAIL, WHERE
NEW PIPE IS REQ., FABRICATE
TO MATCH EXIST.

3/4" x 3/4" ST. BARS @
8" C/C. WELD TO L

PROVIDE 2 1/2" PIPE
SLEEVES FOR NEW
RAILING. SET RAILING
1/4" FOR ROCK

NEW CONC. CURB

EXIST. OR NEW
CONC. SLAB

FOR TYP. RAILING
ELEVATION SEE DET.



RAILING SECTION

SC: 1/2" = 1'-0"

NOTE: CONTRACTOR MUST
VERIFY EXIST. RAILING
CONDITIONS. SHOP DRIVELS
ARE REQ. FOR ALL RAILINGS.

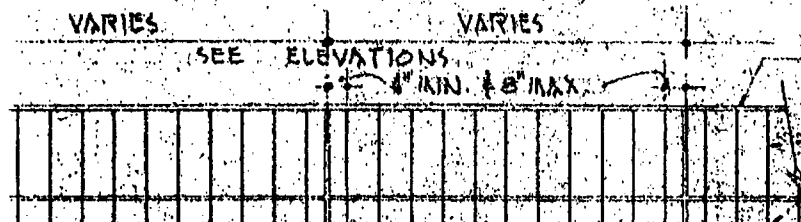

2x9x1/4 L CONTIN.

3/4" ST. BARS
@ 8" C/C.

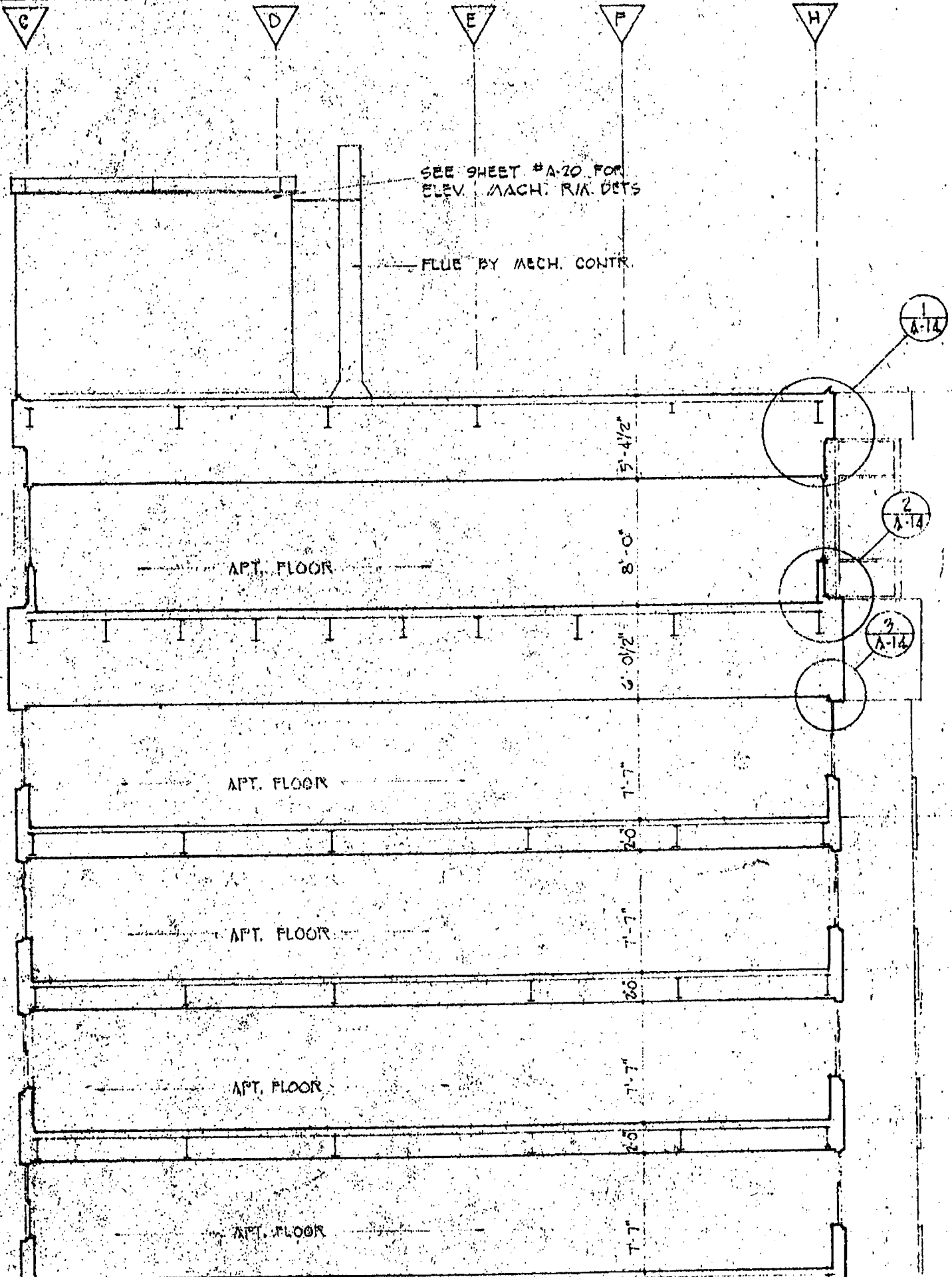

J

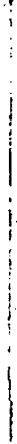

K



13' - 4 1/2"

13' - 7 1/2"

9' - 7"

9' - 7"

9' - 7"

9TH FLR. ROOF SLAB EL. 275'-1"

9TH FLR EL. 261'-8 1/2"

8TH FLR EL. 248'-1"

7TH FLR EL. 238'-6"

6TH FLR EL. 228'-11"

5TH FLR EL. 219'-4"

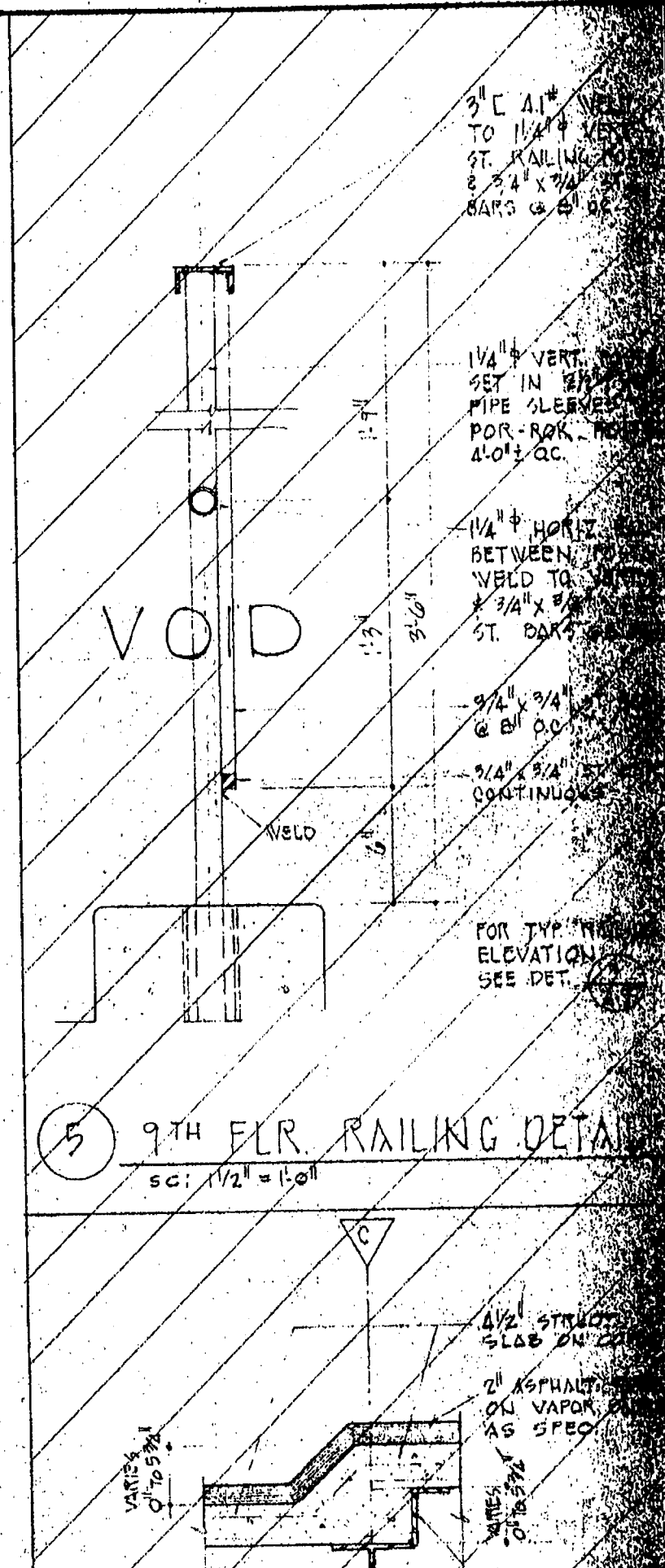

3" E A.I.
TO 1 1/2" ST. RAILING
8 3/4" x 7/8" BARS @ 6" OC

1/4" VERT. SET IN PIPE SLEEVES POR-ROK TO 40' ± OC.

1/4" HORIZ. BETWEEN WELD TO ST. BARS

3/4" x 3/4" @ 6" OC CONTINUOUS

FOR TYP. ELEVATION SEE DET.

5 9TH FLR. RAILING DETAIL
SC: 1/2" = 1'-0"

4 1/2" STRONG SLAB ON 2" ASPHALT ON VAPOR AS SPEC

VARIABLE 0" TO 5/8"

VARIABLE 0" TO 5/8"

revision	date	job no
1	2-8-67	12-2-5
		5-2-67
	10-25-66	6519

ASSOCIATES, INC - architects
N E B R A S K A

3 TYP PARTIAL RAILING ELEVATION

SC: 1/4"

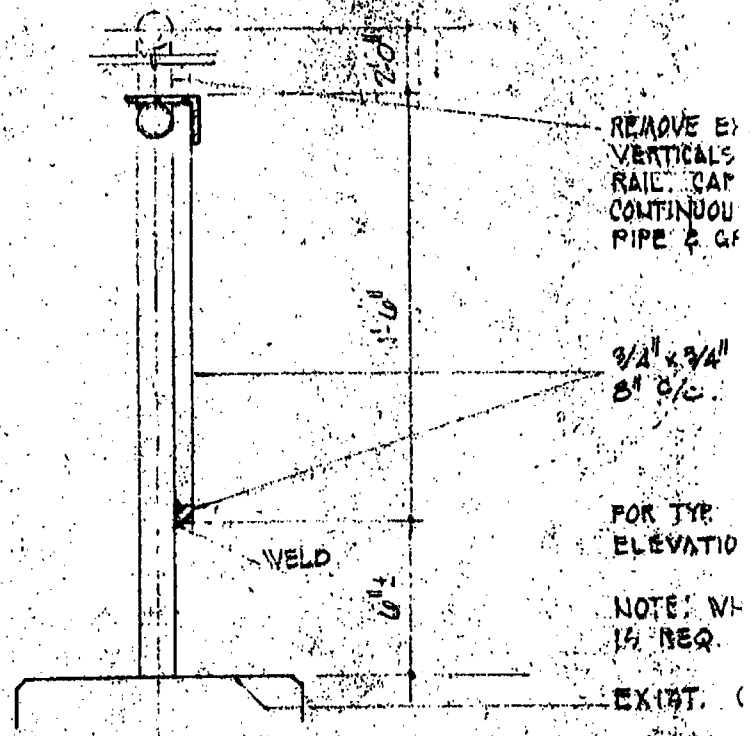

4 RAILING SECTION AT SOUTH & WEST WA

SC: 1/2" = 1'-0"

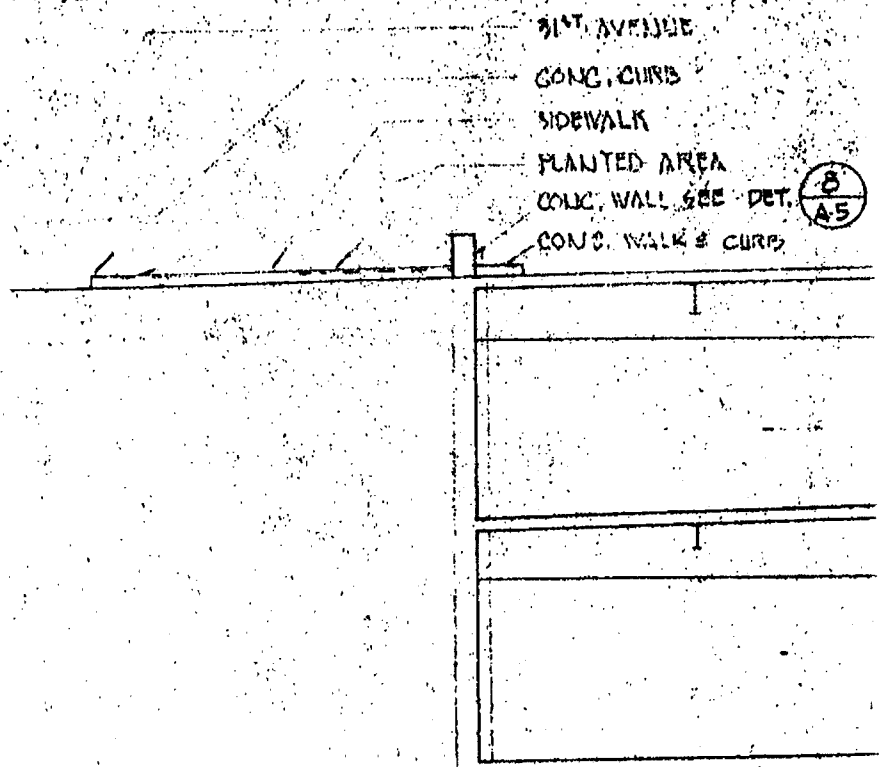

CONC. CURB

1'-0"

EXIST. TOP RAIL &
LS TO MIDDLE
OF WITH 2"x3"x1/4" L
CORS. WELD TO 1/4" φ
GRIND SMOOTH

4" ST. BARS &
WELD TO L

RAILING
TION SEE DET. (3)
A-5

WHERE NEW PIPE RAIL
Q. FABRICATE TO MATCH EXST.

CONC.

WALL MIDDLE PARKING

(5)

REVERSED (4)
A-8

PARKING AREA

CONC. FINISH SEE DET. (1)
A-6
PARKING AREA

REVERSED (4)
A-14

REVERSED (5)
A-14

REVERSED (6)
A-14

CANOPY

CATWALK
SEE DET. (2)
A-13

2ND FLR. COMMERCIAL SPACE

1ST FLR. COMMERCIAL SPACE

CORE WALLS

CONC. WALK

CORE WALLS

CONC. WALK SEE DET. (7)
A-7

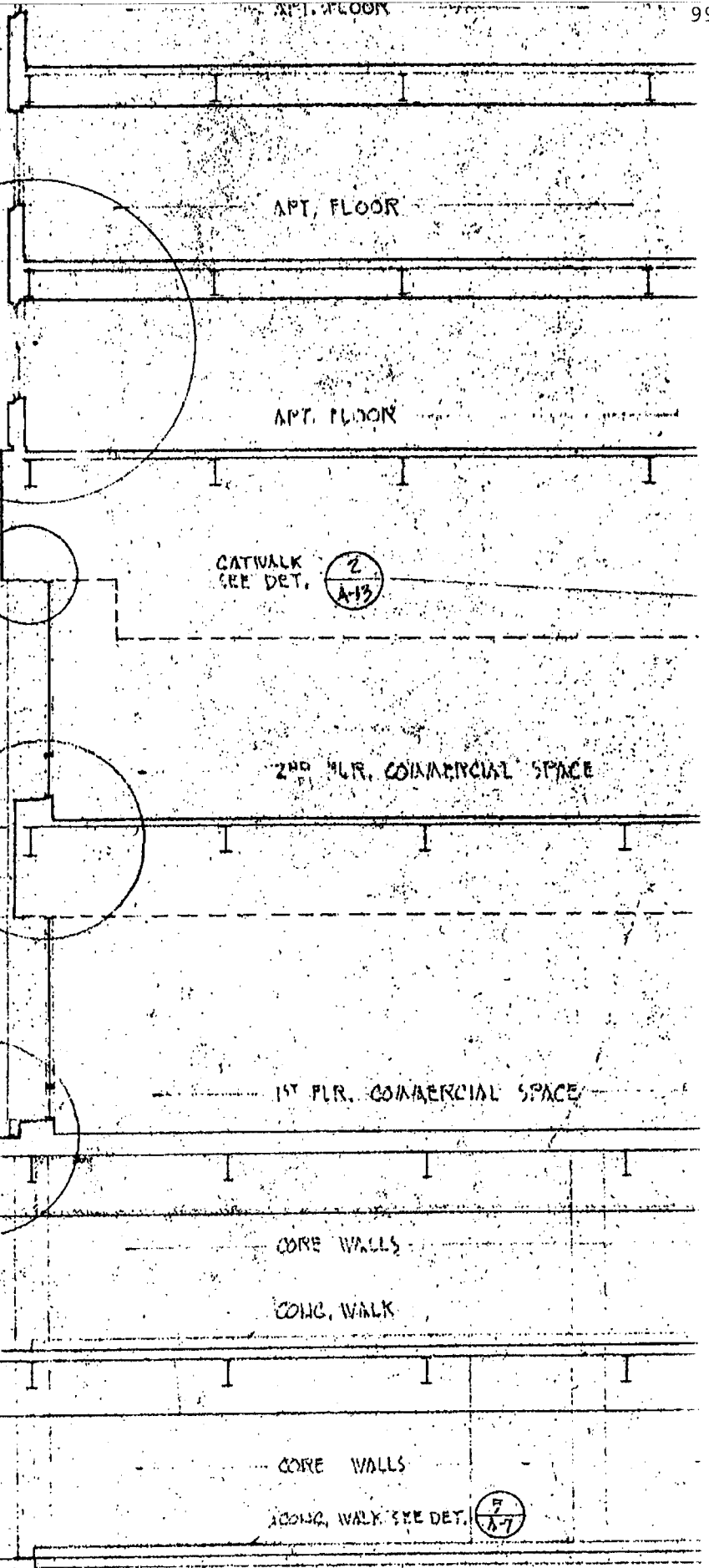
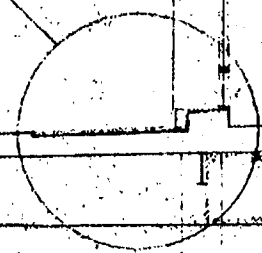
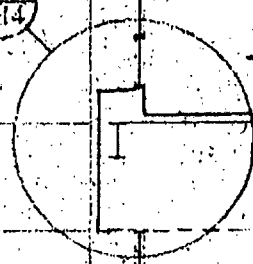
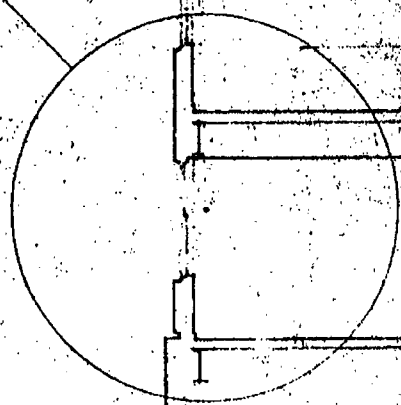

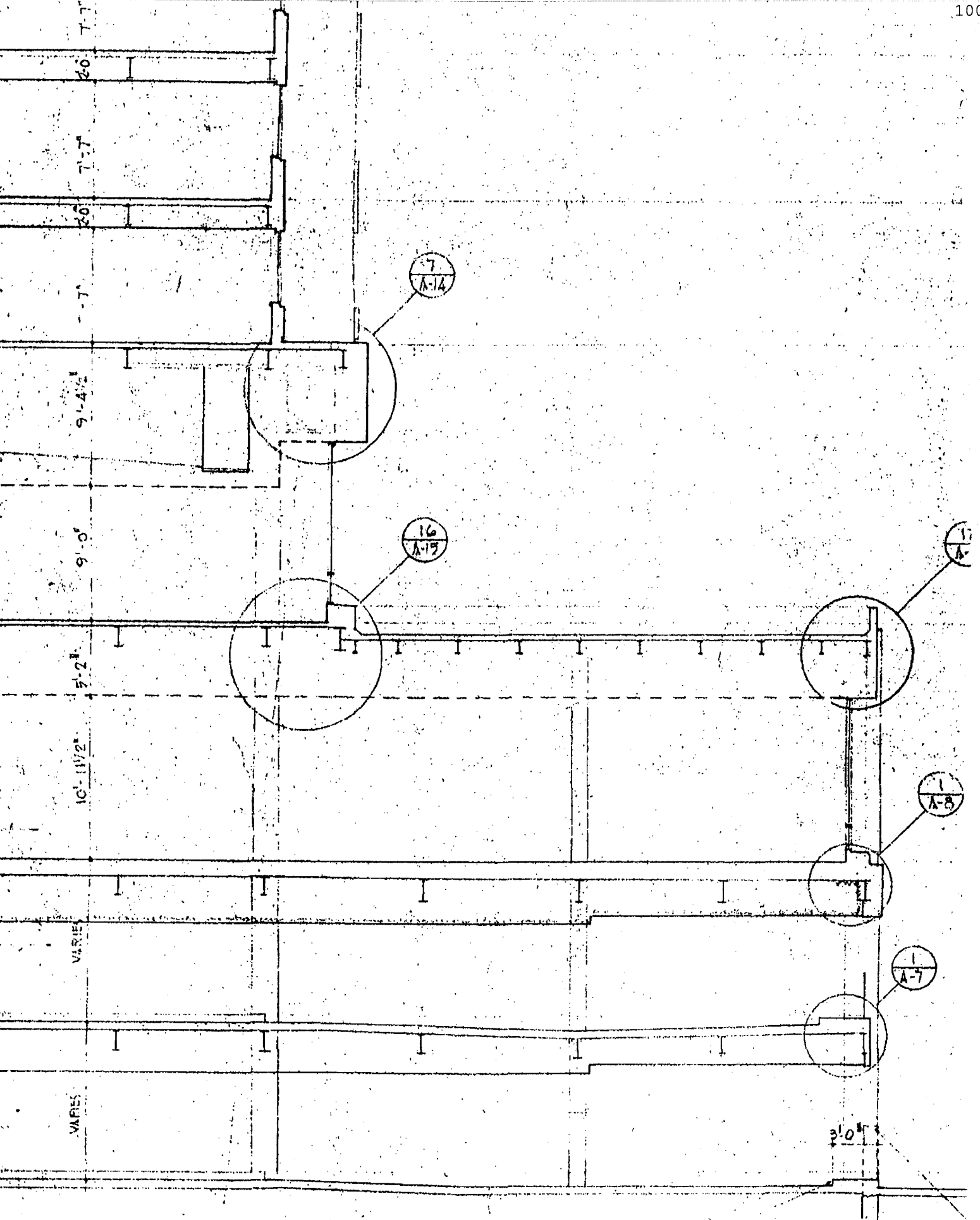

NEW 6" CONC

5TH FLR EL. 219'-4"

9'-7"

4TH FLR EL. 209'-9"

9'-7"

3RD FLR EL. 200'-2"

8'-6"

2ND FLR EL. 191'-8"

10'-0"

1ST FLR. CORE EL. 165'-8"

10'-0"

MIDDLE LEVEL CORE EL. 155'-2"

10'-0"

LOWER LEVEL CORE EL. 144'-8"

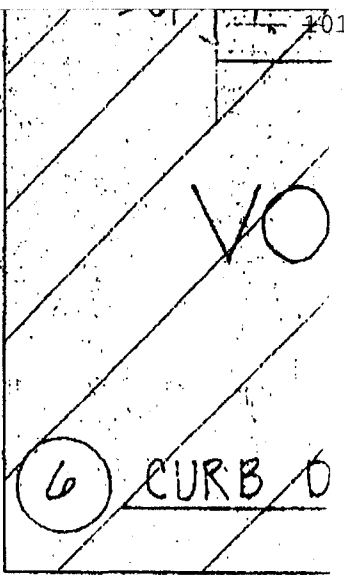

7 FASCIA, S
 SCI: 1/2" x 1'-0"

- NOTE: PLASTERED W/
1. CONC. WALL ALC PARKING LEVEL
 2. CONC. WALL ALC FLR. LEVEL
 3. CONC. WALL ALC PARKING LEVEL
 4. CONC. WALL ALC LINES 'A' AND 'C'

NEW RAILING
 EXIST. CONC. WALL
 NEW CONC. PAVING

GRADE LINE

REMOVE EXISTING

17
A-19

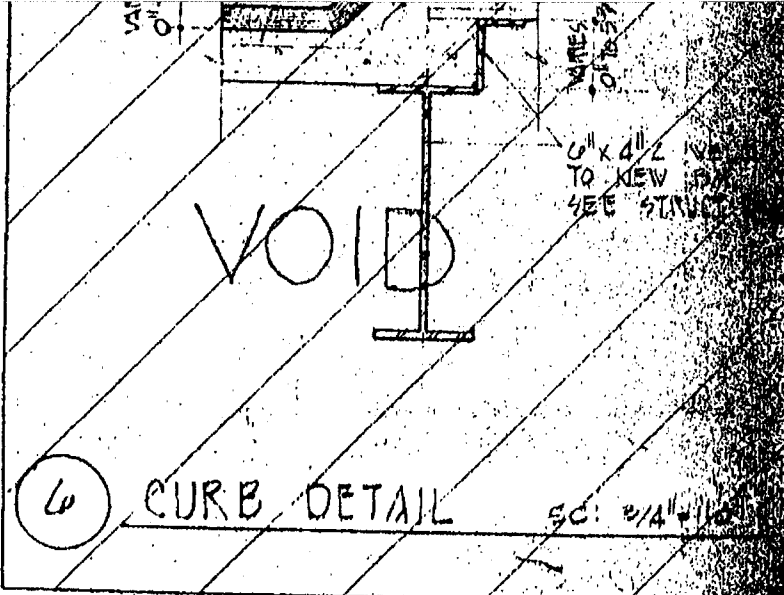

6

CURB DETAIL

SC: 3/4" x 1/2"

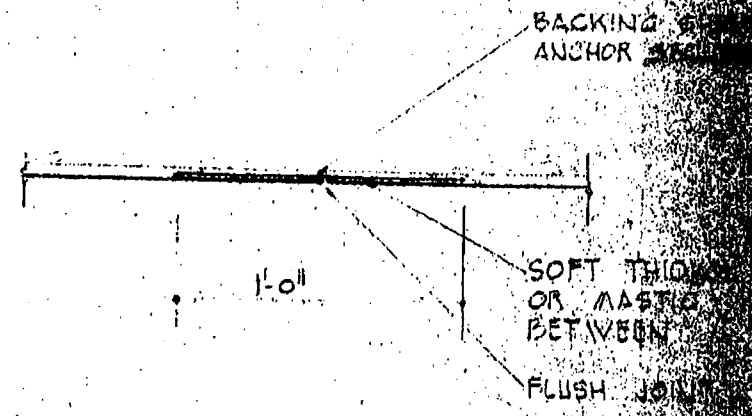

7

FASCIA, SILL, CAP & FLASHING DET

SC: 1 1/2" x 1'-0"

- NOTE: PLASTERED WALL DETAIL APPLIES TO:
1. CONC. WALL ALONG COL. LINE '12' @ MIDDLE PARKING LEVEL
 2. CONC. WALL ALONG COL. LINE 'A' @ 1ST FLR. LEVEL
 3. CONC. WALL ALONG COL. LINE 'A' @ MIDDLE PARKING LEVEL BETWEEN COL. LINES '11' AND '12'
 4. CONC. WALL ALONG COL. LINE '1' BETWEEN COL. LINES 'A' AND 'C' WHERE EXPOSED TO EXTERIOR

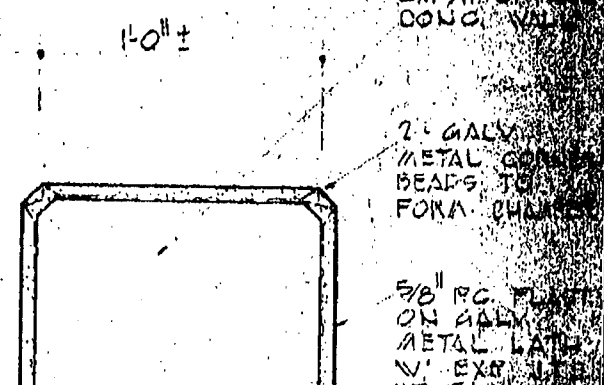

NICAS - GOLDSTEIN & AS
O M A H A

INGA

E HOUSE
NEBRASKA

EXHIBIT "C"
ALLOCATED INTERESTS

Park Plaza Condos
Cost Allocation

Unit	Former Unit	Sq. Ft.	% allocation of Common Elements and Project
301	3a	804	1.37%
302	3b	840	1.43%
303	3c	1,093	1.86%
304	3d	557	0.95%
305	3e	756	1.29%
306	3f	535	0.91%
307	3g	570	0.97%
308	3h	810	1.38%
309	3i	785	1.34%
401	4a	804	1.37%
402	4b	840	1.43%
403	4c	1,093	1.86%
404	4d	557	0.95%
405	4e	756	1.29%
406	4f	535	0.91%
407	4g	570	0.97%
408	4h	810	1.38%
409	4i	785	1.34%
501	5a	804	1.37%
502	5b	840	1.43%
503	5c	1,093	1.86%
504	5d	557	0.95%
505	5e	756	1.29%
506	5f	535	0.91%
507	5g	570	0.97%
508	5h	810	1.38%
509	5i	785	1.34%
601	6a	804	1.37%
602	6b	840	1.43%
603	6c	1,093	1.86%
604	6d	557	0.95%
605	6e	756	1.29%
606	6f	535	0.91%
607	6g	570	0.97%
608	6h	810	1.38%
609	6i	785	1.34%
701	7a	804	1.37%
702	7b	840	1.43%
703	7c	1,093	1.86%
704	7d	557	0.95%
705	7e	756	1.29%
706	7f	535	0.91%
707	7g	570	0.97%
708	7h	810	1.38%
709	7i	785	1.34%
801	8a	804	1.37%
802	8b	840	1.43%
803	8c	1,093	1.86%
804	8d	557	0.95%
805	8e	756	1.29%
806	8f	535	0.91%
807	8g	570	0.97%
808	8h	810	1.38%
809	8i	785	1.34%
901	9a	1,330	2.26%
902	9b	1,050	1.79%
903	9c	1,203	2.05%
904	9d	1,599	2.72%
905	9e	1,582	2.69%
	Floors 1&2	<u>11,500</u>	<u>19.57%</u>
		58,764	100.00%

**EXHIBIT D
BY-LAWS OF PARK PLAZA CONDOMINIUM
ASSOCIATION, INC.**

**ARTICLE I
NAME AND LOCATION**

The name of the Corporation is PARK PLAZA CONDOMINIUM ASSOCIATION, INC., hereinafter referred to as the "Association". The principal office of the corporation shall be as designated by the Board of Directors from time to time, and meetings of Members and Directors may be held at such places within Douglas County, Nebraska, as may be designated by the Board of Directors.

**ARTICLE II
DEFINITIONS**

All terms shall be defined in accordance with the definitions contained in the Declaration and Master Deed of Park Plaza Condominium Property Regime and By-Laws and any amendments thereto (the "Declaration").

**ARTICLE III
PROPERTY RIGHTS; RIGHTS OF ENJOYMENT**

Each Member shall be entitled to the use and enjoyment of the Common Elements and facilities as provided in the Declaration. Any Member may assign his rights of enjoyment of the Common Elements and facilities to the members of his family or his or her tenants who reside on the Property, or any contract purchasers.

**ARTICLE IV
MEMBERSHIP**

Section 1: Membership. The membership of the Association shall consist of all Owners of Condominium Units in the Park Plaza Condominium Property Regime. Membership in the Association shall be mandatory and no Owner during his ownership of a Condominium Unit shall have the right to relinquish or terminate his membership in the Association. The foregoing is not intended to include persons or entities that hold an interest merely as security for the performance of an obligation.

Section 2: Succession. The membership of each Condominium Unit Owner shall terminate when they cease to be an Owner of a Condominium Unit, and their membership in the Association shall automatically be transferred to the new Owner succeeding to such ownership interest.

**ARTICLE V
MEMBERSHIP MEETINGS**

Section 1: Annual Meeting. The annual meeting of the Association shall be held at the office of the Association or at such other suitable place convenient to the Unit Owners as may be designated by the Board at least forty-five (45) days before the beginning of each fiscal year. Each annual meeting shall be for the purpose of electing Directors and transacting any other business authorized to be transacted by the Members. If the date set for the annual meeting of the Membership is a legal holiday, the meeting will be held at the same hour on the first day following such legal holiday.

Section 2: Special Meetings. Special meetings shall be held whenever called by the President or Vice-President or by a majority of the Association's Board of Directors, and must be called by such officers upon receipt of a written request from Members entitled to cast one-third of the votes of the entire membership.

Section 3: Notice of Meetings. Notice of all meetings, stating the time, date, place and purpose for which the meeting is called, shall be given by the President or Vice-President or Secretary, unless waived in writing. Such notice shall be in writing to each Member at the last known address shown on the records of the Association and shall be mailed at least ten (10) days but no more than sixty (60) days prior to the date of the meeting. Proof of such mailings shall be made by affidavit, duly executed by the Person giving the notice. Notice of meeting may be waived before or after any such meeting.

Section 4: Quorum. A Quorum at any meeting shall consist of twenty (20%) percent of those Persons entitled to cast all votes of the Association. If any meeting of the Members cannot be organized because a quorum has not attended, the Members present either in Person or by proxy, may adjourn the meeting for at least ten (10) days, and adequate notice of the new date shall be given as described in Section 3 of this Article.

Section 5: Voting.

(a) Unless specifically required by the Declaration, each Member shall be entitled to cast one vote for each Unit owned by that Member. If a Unit is owned by one person, his/her right to vote shall be established by the record title to the Unit. If a Unit is owned by more than one Person, or if a Unit is owned by a corporation, limited liability company, partnership, trust or any other organization, the vote for such Unit shall be exercised as such multiple Owners or representatives thereof, between or among themselves, determined; provided in no event shall more than one (1) vote be cast with respect to any Unit. In the event of disagreement among such multiple Persons or representatives of such corporation, limited liability company, partnership, trust or any other organization and an attempt by two (2) or more of them to cast such vote or votes, such Persons shall not be recognized, and such vote or votes shall not be counted. No Owner shall be eligible to vote, either in person or by proxy, if that Owner is shown in the books or management accounts of the Association to be more than sixty (60) days delinquent in any payment due the Association or is under suspension for the infraction of any provision of the Declaration or any rule or provision of the Condominium Documents.

(b) Except where a greater number is required by Act or the Declaration, a majority vote is required to adopt decisions at any meeting of the Association. If the Declarant owns or holds title to one or more Units, the Declarant shall have the right at any meeting of the Association to cast one vote for each Unit it owns.

(c) As to any decisions or issues relating to the Units or the Limited Common Elements, the Association shall vote as follows: (i) with respect to any matters relating to the Residential Unit(s) or Limited Common Element(s) relating thereto, only the Residential Units shall be entitled to vote; (ii) with respect to the Commercial/Office Unit(s) (or any portion thereof) or any Limited Common Element(s) relating thereto, only the Owner(s) of the Commercial/Office Unit shall be entitled to vote; and (iii) with respect to the Common Elements, including, but not limited to, the roof, structure, exterior walls and exterior appearance of the Condominium, exterior appearance of the Condominium, or utilities from the right-of-way to the Condominium and sidewalks, shall be the combined majority vote of the Residential Unit Owners Committee and the Commercial/Office Unit Owners Committee.

Section 6: Proxies. Votes may be cast in Person or by proxy as provided in the Act.

ARTICLE VI
BOARD OF DIRECTORS

Section 1: Original Number. During the Period of Declarant Control, the business of the Association shall be managed by a Board of Directors of at least three (3) Directors who shall be appointed by the Declarant and shall serve without compensation. However, any Director may be reimbursed for his actual expenses incurred in the performance of his duties as a Director. At end of the Period of Declarant Control, the membership of the Board

shall always be comprised of five (5) Persons, two (2) of which must be elected by the Commercial/Office Unit Owners and three (3) of which must be elected by the Residential Unit Owners.

Section 2: Term of Office. Other than the three (3) Directors appointed by Declarant during the Period of Declarant Control, the Directors shall be elected as provided in the Declaration and these By-Laws. The Directors appointed by the Declarant shall be elected for terms staggered on a one (1), two (2) and three (3) year basis. After the initial term of each such Director, all thereafter, Directors shall be elected for two (2) years terms. Without regard to the time when the Period of Declarant Control terminates, the Association shall hold a First Transitional Election not later than sixty (60) days after the conveyance of twenty-five (25%) percent of the Residential Units to the Residential Unit Owners other than Declarant, at which election one (1) additional member shall be elected to the Board. A Second Transitional Election shall be held by the Association not later than sixty (60) days after the conveyance of a total of fifty (50%) percent of the Residential Units to Residential Unit Owners other than Declarant, at which election one (1) additional member shall be elected to the Board. The transitional Directors shall be elected for two (2) year terms. At the first annual meeting of the Association following the transition election, if the Period of Declarant Control is still in effect, the Declarant shall appoint three (3) members of the Board and the Unit Owners other than Declarant shall elect the remaining Board members. If the Period of Declarant Control has ended, the Residential Unit Owners shall elect three (3) members to the Board and the Commercial/Office Unit Owners shall elect two (2) members to the Board. Each Director shall serve for the term set forth hereinabove and until his or her successor is duly elected and qualified, or until removed from office as provided herein.

Section 3: Qualifications. The Directors appointed by the Declarant or elected by the Commercial/Office Unit Owners need not be resident of the State of Nebraska nor members of the Association. The Directors elected by the Residential Unit Owners need not be resident of the State of Nebraska, but must be members of the Association. If a Director shall cease to meet such qualifications during their term, he will thereupon cease to be a Director, and his place on the Board shall be deemed vacant. The requirements of this Section shall not apply to Directors appointed by the Declarant.

Section 4: Removal. Other than the Directors appointed by the Declarant, any Director may be removed from the Board, with or without cause, by concurrence of a Super-Majority Vote of the Members.

Section 5: Vacancies. In the event of the death, resignation or removal of a Director, their successor shall be selected by a majority of the remaining members of the Board and shall serve for the unexpired term of their predecessor.

ARTICLE VII NOMINATION AND ELECTION OF DIRECTORS

Section 1: Nomination. After the termination of the Period of Declarant Control, nomination for election to the Board shall be made by any Unit Owner. Nominations may also be made from the floor at the annual meeting by a Member in good standing.

Section 2: Election. The election shall be by ballot (unless dispensed with by unanimous consent) and by a plurality of votes cast. Each person entitled to vote may cast his vote for each of as many nominees as there are vacancies to be filled. There shall be no cumulative voting.

ARTICLE VIII
MEETING OF DIRECTORS

Section 1: Regular Meeting. Regular meetings of the Board of Directors shall be held at such times and places which are determined, from time to time, by a majority of the Association's Board of Directors. Notice of regular meetings shall be given to each Director, personally or by mail, telephone or equivalent service, at least five (5) days prior to the date of any regular meeting. Notice of meeting may be waived before or after any such meeting.

Section 2: Special Meetings. Special meetings of the Board of Directors may be held at the request of the President, Vice-President or Secretary, and must be held at the written request of two-thirds (2/3) of the Directors. Notice of special meetings shall be given to each Director, personally or by mail, telephone or equivalent service, at least five (5) days prior to the date of any special meeting. Such notice shall state the time, date, place and purpose of the special meeting. Notice of meeting may be waived before or after any such meeting.

Section 3: Quorum. A quorum at Director's meetings shall consist of fifty (50%) percent of the votes (in person or by proxy) thus represented of the entire Association's Board of Directors present at the beginning of a meeting. The acts approved by a majority of those Directors present at any meeting at which a quorum is present shall constitute the acts of the Association, except where approval by a greater number of Directors is required by the Declaration of Condominium or these By-Laws. If at any meeting of the Board of Directors less than a quorum is present, the majority of those present may adjourn the meeting until a quorum is present. Upon reconvening an adjourned meeting, any business called may be transacted without the necessity of providing any further notice. Directors may attend any such meeting in person or by proxy or by telephonic or video conference call.

Section 4: Action Taken Without A Meeting. The Directors shall have the right to take any action in the absence of a meeting which they could take at a meeting by obtaining the written approval of all Directors. Any action so approved shall have the same effect as though taken at a meeting of the Directors.

Section 5: Common or Interested Board Members. Each Director shall exercise such Director's powers and duties in good faith and with a view to the interests of the Condominium. No contract or other transaction between the Association and any of its Board members; or between the Association and any corporation, firm or association (including the Declarant) in which any of the Board members of the Association are directors or officers or are pecuniarily or otherwise interested, is either void or voidable because any such member is present at the meeting of the Board or any committee thereof which authorizes or approves the contract or transaction, or because such Director's vote is counted for such purpose, if any of the conditions specified in any of the followings subsections exist:

(a) The fact of the common directorate or interest is disclosed or known to the Board or a majority thereof or noted in the minutes, and the Board authorizes, approves or ratifies such contract or transaction in good faith by a vote sufficient for the purpose;

(b) The fact of the common directorate or interest is disclosed or known to at least a majority of the Unit Owners, and the Unit Owners approve or ratify the contract or transaction in good faith by a vote sufficient for the purpose; or

(c) The contract or transaction is commercially reasonable to the Association at the time it is authorized, ratified, approved or executed.

Any common or interested Board members may be counted in determining the presence of a quorum of any meeting of the Board or committee thereof which authorizes, approves or ratifies any contract or transaction, and

may vote at the meeting to authorize any contract or transaction with like force and effect as if such Board member of the Association were not an officer or director of such other corporation, firm or association or not so interested.

ARTICLE IX
POWERS AND DUTIES OF THE BOARD OF DIRECTORS

Section 1: Powers. The Board of Directors shall have the power to:

- (a) Elect and remove the officers of the Association;
- (b) Adopt and publish rules and regulations governing the use of the Common Elements, Limited Common Elements and related facilities, and the personal conduct of the Members and their guests thereon, and to establish penalties for the infraction thereof;
- (c) Suspend the right of a Member to vote during any period when such Member shall be sixty (60) days or more delinquent in the payment of any assessments levied by the Association or such Member is in default under any other terms and conditions of the Declaration. Such right may also be suspended after notice and hearing, for a period not to exceed ninety (90) days, for infraction of published rules and regulations promulgated by the Board;
- (d) Engage the services of an agent, manager, independent contractors or employees as they deem necessary to maintain, repair, replace, administer and operate the Common Elements, or any part thereof, and manage all other affairs and business of the Association for all of the Members, upon such terms and for such compensation as the Board may approve. Any agreement for the services of any such agent, manager, independent contractor or employee shall provide for termination by the Association with or without cause, and without payment of a termination fee, upon thirty (30) days' written notice, and no such agreement shall be of a duration in excess of one (1) year, renewable by agreement of the parties for successive one (1) year periods;
- (e) Make repairs within the individual Condominium Units where such repairs are required for the welfare or safety of other Condominium Unit Owners, or for the preservation or protection of the Common Elements;
- (f) Grant or relocate easements over, across or through the Common Elements as the Board may determine to be beneficial to the Members;
- (g) Declare the office of a Member of the Board to be vacant in the event such Member shall be absent from three (3) consecutive regular meetings of the Board;
- (h) Pursuant to Article VI of the Declaration, the Board shall establish, supervise and delegate their duties to a Residential Unit Owners Committee which may govern the Residential Units and related Limited Common Elements and a Commercial/Office Unit Owner(s) Committee which may govern the Commercial/Office Unit(s) and related Limited Common Elements. Each such committee shall have the power to: (a) enact resolutions regarding the applicable Units and related Limited Common Elements which shall be ratified, adopted and carried out by the Board or the Association; (b) vote for special assessments for expenses and matters pertaining to the applicable Units and Limited Common Elements related thereto; and (c) perform all duties or other acts that may be required, permitted or delegated to it by the Board or the Association; and
- (i) Exercise for the Association all powers, duties and authority vested in or delegated to the Association and not reserved to the Members by other provisions of these By-Laws, the Articles of Incorporation or the Declaration.

Section 2: Duties. It shall be the duty of the Board of directors:

- (a) To cause to be kept a record of all acts and corporate affairs;
- (b) To supervise all officers, agents and employees of this Association, and to see that their duties are properly performed;
- (c) As more fully provided herein and in the Declaration:
 - (i) To fix the annual assessment in accordance with the terms and conditions of the Declaration; and
 - (ii) To send written notice of any change in assessment to every Owner subject thereto in accordance with the terms and conditions of the Declaration;
- (d) To issue, or cause an appropriate officer to issue, upon demand by any person, a certificate setting forth whether any assessment has been paid. A reasonable charge may be made by the Board for the issuance of these certificates. Such certificates shall be conclusive evidence of the payment of any assessment therein stated to have been paid;
- (e) To procure and maintain adequate liability insurance, and to procure adequate hazard insurance on property owned by the Association;
- (f) To cause all officers or employees having fiscal responsibilities to be bonded;
- (g) To cause the Common Elements to be maintained; and
- (h) To cause all other affairs and business of the Association to be properly conducted and administrated.

ARTICLE X
OFFICERS AND THEIR DUTIES

Section 1: Enumeration of Officers. The executive officers of the Association shall consist of a President, (who must also be a Director), a Vice-President, Treasurer, and Secretary.

Section 2: Election of Officers. The election of officers shall be made by a majority vote of the Board of Directors at the first meeting of the Board following each annual meeting of the Membership.

Section 3: Term. The officers of this Association shall be elected annually by the Board and each shall hold office for one (1) year unless they shall sooner resign, or shall be removed, or otherwise become disqualified to serve.

Section 4: Special Appointments. The Board may elect such other officers as the affairs of the Association may require, each of whom shall hold office for such period, have such authority, and perform such duties as the Board may, from time to time, determine.

Section 5: Resignation and Removal. Any officer may be removed from office with or without cause by the Board. Any officer may resign at any time by giving written notice to the Board, the President or the Secretary.

Such resignation shall take effect on the date of receipt of such notice or at any later time specified therein, and unless otherwise specified therein, the acceptance of such resignation shall not be necessary to make it effective.

Section 6: Vacancies. A vacancy in any office may be filled by a majority vote of the quorum present of the Directors. The officer elected to such vacancy shall serve for the remainder of the term of the officer replaced.

Section 7: Multiple Offices. Any two or more offices may be held by the same person, except the offices of President and Secretary.

Section 8: Duties. The duties of the officers are as follows:

(a) President. The President shall be the Chief Executive Officer of the Association, and shall supervise and control all of the business and affairs of the Association. The President shall, when present, preside at all meetings of the Members and all meetings of the Board. The President may sign, with or without any other officer of the Association as authorized by the Board, deeds, mortgages, bonds, contracts or other instruments which the Board has authorized to be executed, except where the signing and the execution thereof shall be expressly delegated by the Board or by these By-Laws to some other officer or agent of the Association or shall be required by law to be otherwise signed or executed. The President shall have the power to appoint and remove one or more administrative Vice-Presidents of the Association and such other assistants to the various elected officers of the Association as is necessary of the accomplishment of their duties. In general, the President shall perform all duties incident to the office of the President and such other duties as may be prescribed by the Board.

(b) Vice-President. In the absence of the President, or in the event of the President's death, inability or refusal to act, the Vice-President, or if there is more than one Vice-President, the Senior Vice-President, shall perform the duties of the President, and when so acting shall have all the powers, of, and be subject to, all the restrictions upon the President. Otherwise, such Senior and other Vice-Presidents shall perform only such duties as may be assigned by the President or by the Board.

(c) Secretary. The Secretary shall keep the minutes of the meetings of the Members and the Board in one or more books provided for that purpose; see that all notices are duly given in accordance with the provisions of these By-Laws, or as required by law; be custodian of the records of the Association except those of the Treasurer; keep or cause to be kept under their general supervision by a registrar or transfer agent appointed by the Board, a register of the name and post office address of each Member as furnished by such Member; have general charge of the transfer books of the corporation; and in general perform all duties incidental to the office of the Secretary and such other duties as may be assigned to them by the President or by the Board.

(d) Treasurer. The Treasurer shall have charge and custody of, and be responsible for, all funds and securities of the Association; receive and give receipts for monies due and payable to the corporation from any source whatsoever, and deposit all monies in the name of the Association in such banks, trust companies or other depositories as shall be directed by the Board; shall sign all checks and promissory notes of the Association except in those instances where the Board has delegated the authority to sign checks to a managing agent employed by the Association; shall keep proper books of account; shall cause an annual audit of the books of the Association to be made by an independent certified public accountant at the completion of each fiscal year; and shall prepare an annual budget and a statement of income and expenditures to be presented to the Members at the regular annual meeting of the Members, and shall deliver a copy of such to the Members. The duties of the Treasurer may be performed by the managing agent.

Section 9: Committees. In addition to the Residential Unit Owners Association and the Commercial/Office Unit Owners Association, which shall be established pursuant to Article IX-Section 1(h) above, the Board may appoint and establish a nominating committee, as provided in these By-Laws, and such other committees as the Board may deem appropriate to carry out the purposes of the Association.

ARTICLE XI
BOOKS AND RECORDS

Section 1: Inspection of Association Books and Records.

(a) The Association shall retain in its records the current Articles of Incorporation, Bylaws, Declaration, Association rules, Master Declaration, Master Declaration rules and regulations, insurance policies, contracts entered into by the Association, together with books of account, records, and minutes of proceedings of the Members and Directors (herein "Books and Records").

(b) The membership register or duplicate membership register (including mailing addresses and telephone numbers), and Books and Records shall be open to inspection upon the written demand of any Member, at any reasonable time, for a purpose reasonably related to his/her interests as a Member. Such inspection may be made in person or by an agent or attorney. Demands of inspection other than at a Members' meeting shall be made in writing upon the President or Secretary. The Board may adopt reasonable and uniform rules respecting (1) the notice to be given to the custodian of the particular records to be inspected by a Member; (2) the hours and days of the week when such inspection may be made; and (3) payment of the cost to prepare and reproduce copies of documents requested by a Member. The Board may withhold or redact information from the accounting books and records and minutes of proceedings if the release of such information is reasonably likely to lead to identify theft or fraud, or if the information is privileged under law.

(c) Each director shall have the right at any reasonable time to inspect all Books and Records and documents of the Association and physical properties owned or controlled by the Association. The right of inspection by a director includes the right to make extracts and copies of documents.

Section 2: Checks, Drafts, etc. All checks, drafts or other orders for the payment of money, notes or other evidences of indebtedness issued in the name of or payable to the Association shall be signed or endorsed by such person or persons and in such manner as from time to time shall be determined by resolution of the Board.

Section 3: Contract, etc., How Executed. The Board, except as otherwise provided in the Bylaws, may authorize any officer or officers, agent or agents to enter into any contract or execute any instrument in the name of and on behalf of the Association, and such authority may be general or confined to specific instances. Unless so authorized by the Board, no officer, agent or employee shall have any power or authority to bind the Association by a contract or engagement or to pledge its credit or to render it liable for any purpose or for any amount.

Section 4: Balance Sheets, Operating Statements and Budgets. The following financial information shall be regularly prepared and distributed by the Association to all Members:

(a) A budget for each fiscal year consisting of at least the following information shall be distributed not less than forty-five (45) days and not more than sixty (60) days prior to the beginning of the fiscal year:

(i) Estimated revenue and expenses on an accrual basis.

(ii) A summary of the Association's reserves based upon the most recent review or study conducted pursuant to Section 5 below.

(b) A balance sheet as of an accounting date which is the last day of the month closest in time to six months from the date of closing of the first sale of a Unit and an operating statement for the period from the date of the first closing to the said accounting date shall be distributed within sixty (60) days after the accounting date.

(c) A financial statement of the Association shall be prepared in accordance with generally accepted accounting principles by the Board without independent audit or review.

Section 5: Reserve Accounts. At least once every five (5) years the Board shall cause to be conducted a reasonably competent and diligent visual inspection of the accessible areas of the major components which the Association is obligated to repair, replace, restore or maintain as part of a study of the reserve account requirements of the Development. The Board shall review this study annually and shall consider and implement necessary adjustments to the Board's analysis of the reserve account requirements as a result of that review.

The study shall at minimum include:

(i) Identification of the major components which the Association is obligated to repair, replace, restore or maintain which, as of the date of the study, have a remaining useful life of less than thirty (30) years.

(ii) Identification of the probable remaining useful life of the components identified in subsection (i) as of the date of the study.

(iii) An estimate of the cost of repair, replacement, restoration or maintenance of the major components identified in subsection (i) during and at the end of their useful life.

(iv) An estimate of the total annual contribution necessary to defray the cost to repair, replace, restore or maintain the major components during and at the end of their useful life, after subtracting total reserve funds as of the date of the study.

ARTICLE XII INDEMNIFICATION

Section 1: General. The Association shall indemnify and hold harmless each of its Directors and Officers, each member of any committee appointed by the Board, and Declarant, against any and all liability arising out of any acts of the Directors, Officers, Committee Members, Board, or Declarant or arising out of their status as Directors, Officers, Committee Members, or Declarant, unless any such act is a result of gross negligence or criminal intent. It is intended that the foregoing indemnification shall include indemnification against all costs and expenses including, by way of illustration but not of limitation, attorney's fees and costs reasonably incurred in connection with the defense of any claim, action or proceeding, whether civil, criminal, administrative or other, in which any such Director, Officer, Committee Member, or Declarant may be involved by virtue of such person having the status of a Director, Officer, Committee Member, or Declarant, provided, however, that such indemnity shall not be operative with respect to any matters to which such person shall have been finally adjudged in such action or proceeding to be liable for gross negligence or criminal intent in the performance of his duties.

ARTICLE XIII
AMENDMENTS

These By-Laws may only be changed, modified or amended, at a regular or special meeting of the Members, by a Super-Majority Vote.

ARTICLE XIV
MISCELLANEOUS

The fiscal year of the Association shall begin on the first day of January and end on the last day of December of every year, except that the first fiscal year shall begin on the date of incorporation.

IN WITNESS WHEREOF, the undersigned, constituting all of the Directors of the executive Board, have approved these By-Laws this 1 day of April, 2005.

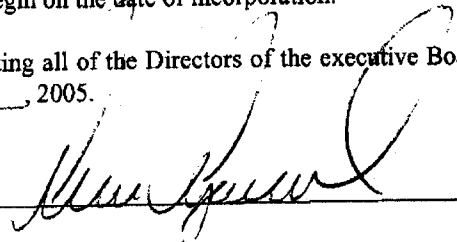

Member